



EIGR-V Series — Skorpion Gigabit Wired VPN Routers

The EIGR-V series consists of high-speed routers that link two 10/100/1000 Mbps Internet Protocol (IPv4) networks — passing appropriate traffic while blocking all other traffic. One network is the local-area-network (LAN); the other is the wide-area-network (WAN). The built-in stateful firewall passes communication initiated on the LAN-side while blocking WAN-side initiated communication. With Port Address Translation (PAT), LAN-side clients can access the Internet. Network Address Translation (NAT) allows a one-to-one translation between LAN-side and WAN-side devices. With Port Forwarding, LAN-

side devices can be accessed from the Internet. The EIGR-V incorporates a four-port Ethernet switch for multiple LAN-side connections. An external Ethernet-based modem — cable or DSL— can be used to connect to the Internet. DSL modems connect via the PPPoE protocol.

The EIGR-V series includes real-time clock and OpenVPN client/server functionality. As a VPN Server, up to 15 router clients and 15 PC clients can be supported. The EIGR-V operates over 0 to 60°C temperature range and the EIGR-VX operates over -40 to +75°C range.

EIGR-V Skorpion Gigabit IP Router Features...

- Web page configuration
- 10/100/1000 Mbps WAN port
- 4-port 10/100/1000 Mbps Ethernet LAN switch
- Secure Virtual Private Network (VPN) Client/Server
- PAT, NAT, Port Forwarding and Port Range Forwarding
- Stateful Firewall and Allowlist
- Remote Router Access and NAT Loopback
- DHCP client (WAN) and DHCP server (LAN)
- DIN-rail mounting
- Diagnostic LEDs
- CE Mark, RoHS, UL 508, C22.2 No. 142-M1987
- 24 VAC/VDC powered
- Operates over 0 to 60°C (EIGR-V)
- Operates over -40 to +75°C (EIGR-VX)



EIGR-V

EIGR-VX

CTRLink®

EIGR-V — Skorpion Gigabit IP Router

Although the EIGR-V has many of the same features found in high-end routers, it is simpler to install and commission. A resident DHCP server on the LAN-side will provide IP addresses to LAN-side clients while a DHCP client on the WAN-side will accept IP address assignments from the attached network.

Static addressing is accommodated as well. Configuration is via a web browser using authentication. With a DIN-rail mounting clip, rugged metal enclosure and the ability to be powered from a low-voltage AC/DC power source, the EIGR-V is ideal IP router for automation systems.

Quick Disconnect 4-pin Power Connector
provides connections to a DC or AC source and a connection for a backup source

35 mm Din-rail Clip
for convenient control panel installation

Writable Label
for a helpful record of connected IP devices

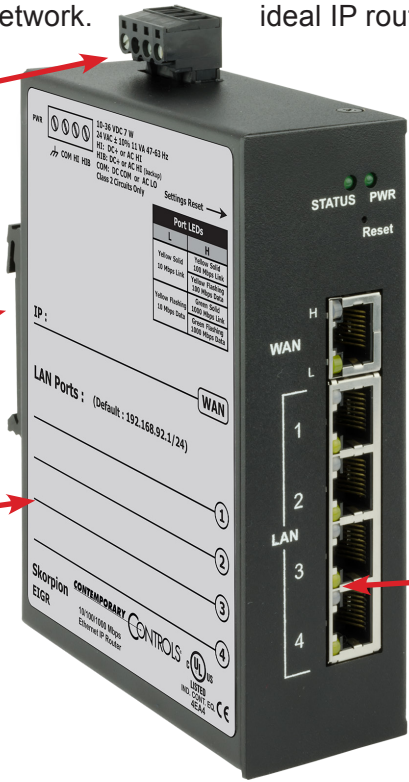

Power LED
Power OK indicator

Reset Switch
returns the EIGR-V to its default settings

Built-in Ethernet Switch
connect up to four 10/100/1000 Mbps Ethernet devices with auto-negotiation and Auto-MDIX

Diagnostic LEDs
indicate the status of Link and Activity

Connector Pin Assignments

Ethernet RJ-45 Pin Assignments

Pin	Function
1	BI_DA+
2	BI_DA-
3	BI_DB+
4	BI_DC+
5	BI_DC-
6	BI_DB-
7	BI_DD+
8	BI_DD-

All ports are Auto-MDIX.

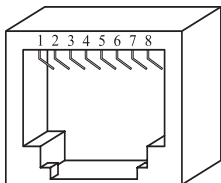

Mechanical Drawing

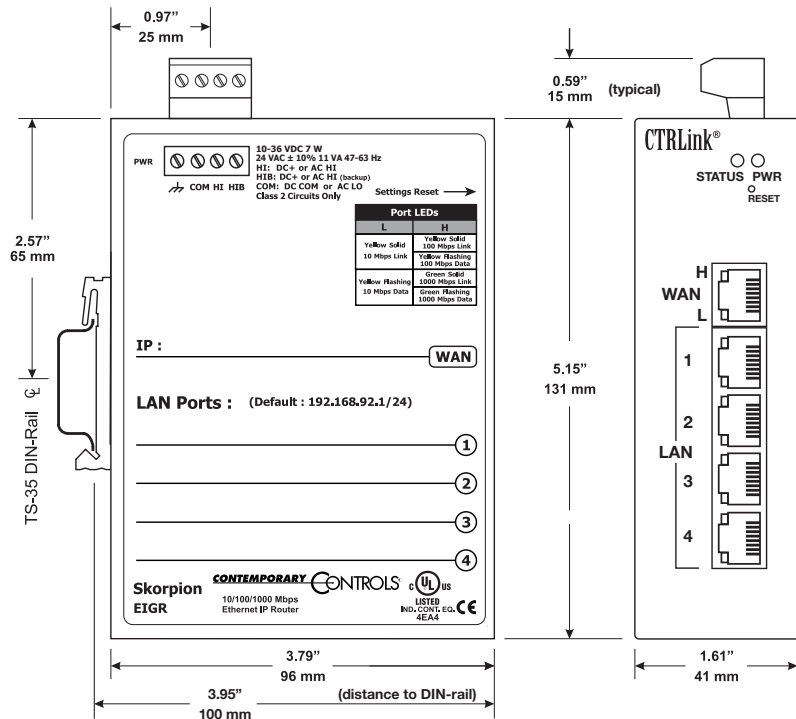

Web Page Configuration



Onboard Help

Setup
Administration
Status
Advanced
Save Changes



Skorpion EIGR GigE Router

Automation Firewall/Router

WAN Setup

Connection Type DHCP

Optional Settings (required by some ISPs)

Host Name:

Domain Name:

MTU: Enable Disable Size:

LAN Setup

Router IP

Local IP Address:

Subnet Mask:

Network Address Server Settings (DHCP)

Local DHCP Server: Enable Disable

Start IP Address:

Number of Addresses:

Client Lease Time:

WAN Setup

Connection Type Static IP

IP Address:

Subnet Mask:

Default Gateway:

Static DNS 1:

Static DNS 2:

Static DNS 3:

Optional Settings (required by some ISPs)

Host Name:

Domain Name:

MTU: Enable Disable Size:

Router Access

Local Router Access

Username:

Password:

Confirm Password:

Remote Router Access

Administration Port:

Enable:

Firewall

Firewall Status: Enable Disable

NAT

WAN IP Address					LAN IP Address				Enabled
<input style="width: 30px;" type="text" value="129"/>	<input style="width: 30px;" type="text" value="250"/>	<input style="width: 30px;" type="text" value="35"/>	<input style="width: 30px;" type="text" value="123"/>	TO	<input style="width: 30px;" type="text" value="192"/>	<input style="width: 30px;" type="text" value="168"/>	<input style="width: 30px;" type="text" value="1"/>	<input style="width: 30px;" type="text" value="119"/>	<input checked="" type="checkbox"/>
<input style="width: 30px;" type="text"/>	<input style="width: 30px;" type="text"/>	<input style="width: 30px;" type="text"/>	<input style="width: 30px;" type="text"/>	TO	<input style="width: 30px;" type="text"/>	<input style="width: 30px;" type="text"/>	<input style="width: 30px;" type="text"/>	<input style="width: 30px;" type="text"/>	<input type="checkbox"/>
<input style="width: 30px;" type="text"/>	<input style="width: 30px;" type="text"/>	<input style="width: 30px;" type="text"/>	<input style="width: 30px;" type="text"/>	TO	<input style="width: 30px;" type="text"/>	<input style="width: 30px;" type="text"/>	<input style="width: 30px;" type="text"/>	<input style="width: 30px;" type="text"/>	<input type="checkbox"/>
<input style="width: 30px;" type="text"/>	<input style="width: 30px;" type="text"/>	<input style="width: 30px;" type="text"/>	<input style="width: 30px;" type="text"/>	TO	<input style="width: 30px;" type="text"/>	<input style="width: 30px;" type="text"/>	<input style="width: 30px;" type="text"/>	<input style="width: 30px;" type="text"/>	<input type="checkbox"/>
<input style="width: 30px;" type="text"/>	<input style="width: 30px;" type="text"/>	<input style="width: 30px;" type="text"/>	<input style="width: 30px;" type="text"/>	TO	<input style="width: 30px;" type="text"/>	<input style="width: 30px;" type="text"/>	<input style="width: 30px;" type="text"/>	<input style="width: 30px;" type="text"/>	<input type="checkbox"/>

OpenVPN Connection Settings

Public IP Address:

OpenVPN Port:

Ping Interval: (secs)

Ping Timeout: (secs)

About This Page

This page is used to perform basic IP settings for the WAN and LAN interfaces - such as IP address, subnet mask, etc. *Connection Type* is used to specify how your EIGR connects to the WAN: *DHCP*, *Static IP*, *PPPoE*, or *PPTP*.

If you select *DHCP*, the WAN side of the EIGR will have its IP address, subnet mask and gateway address set by a DHCP server that is directly or indirectly connected to the WAN port. If no DHCP server is available, static entry values can be entered by selecting connection type *Static IP*. *PPPoE* is normally used by DSL modems. *PPTP* (Point-to-Point Tunneling Protocol) is used by some providers for Internet Access.

The Router IP address is the IP address which you can use to configure the EIGR. This will also be the gateway address used by IP devices connected to the LAN ports of the EIGR.

The **LAN Setup** can be used to enable the DHCP server for the LAN side along with the starting DHCP address, the number of DHCP clients and the lease time (in minutes).

[More Information...](#)

Need Support?

Our staff of engineers is available to

Power Considerations

Applied voltage must be in the specified range and deliver a current commensurate with power consumption. The recommended size for solid power conductors is 16–20 AWG; and for stranded conductors use 16–18

AWG. Zero volts (COM) is isolated from chassis (earth). Input connections are reverse-polarity protected.

Input power: 10–36 VDC or 24 VAC ± 10%, 47–60 Hz.
 Connecting chassis to earth or using a backup source is always optional.
 All options shown are for use in Class 2 circuits if applied voltage is limited to 30V DC.

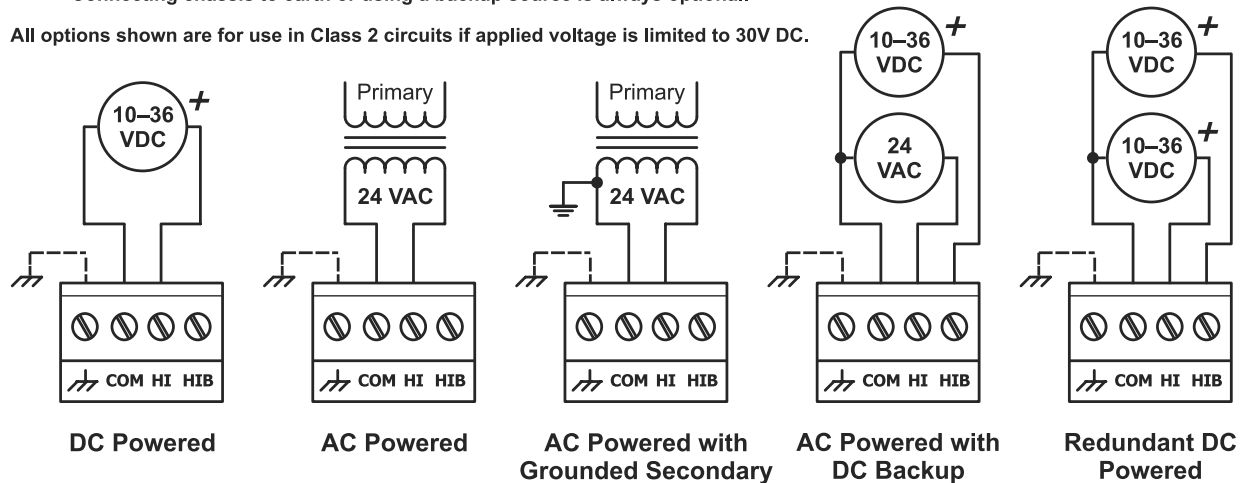

Stateful Firewall — Promotes Secure Communication

The lower part of the router connects the LAN side (the local-area-network). The upper part connects the WAN side (wide-area-network). A firewall (which can be disabled by the user) separates the two parts.

A firewall controls the passing of messages from one side of a router to the other. A *stateful firewall* acts on the structure of the message and who is initiating and who is responding.

Originating requests from the LAN side and corresponding responses from the WAN side **pass through** the firewall. But traffic originating from the WAN side is **blocked** from the LAN side **unless** the firewall is adjusted to allow it. This protects the LAN side from unauthorised WAN access.

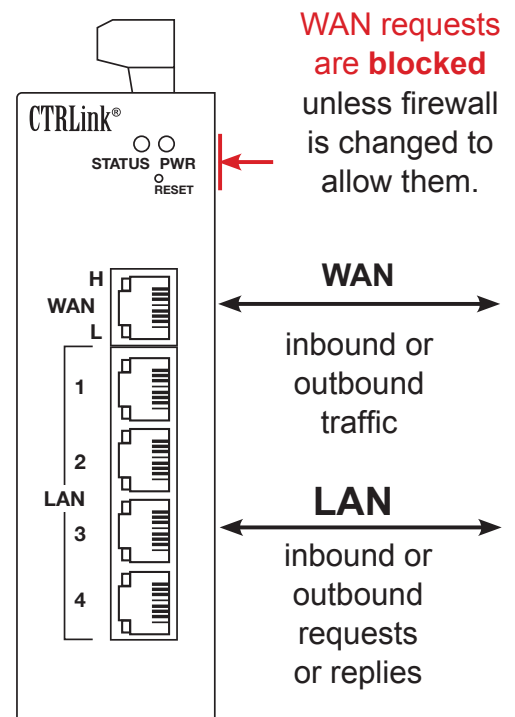

Specifications

Power Requirements	10–36 VDC ±10% 7 W or 24 VAC ±10% 11 VA 47–63 Hz	
Operating Temperature	0 to 60°C (EIGR-V) –40 to +75°C (EIGR-VX)	
Storage Temperature	–40 to +85°C	
Relative Humidity	10–95%, non-condensing	
Protection	IP30	
Mounting	TS-35 DIN-rail	
Ethernet Communications	IEEE 802.3 10/100/1000 Mbps data rate 10BASE-T, 100BASE-TX and 1000BASE-T 100 m (max) CAT5e cable length	
LEDs	PWR	Green = Power OK
	STATUS	Green = Boot up complete
	H	Green = 1000 Mbps communication established Yellow = 100 Mbps communication established Flash = Activity
	L	Yellow = 10 Mbps Flash = Activity

Regulatory Compliance **CE Mark; CFR 47, Part 15 Class A; RoHS;
UL 508; C22.2 No. 142-M1987**

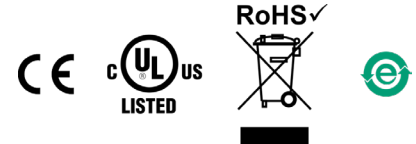

Ordering Information

Model	RoHS	Description
EIGR-V	✓	Skorpion GigE IP Router with VPN 0 to 60°C
EIGR-VX	✓	Skorpion GigE IP Router with VPN –40 to +75°C

<p>United States Contemporary Control Systems, Inc. 2431 Curtiss Street Downers Grove, IL 60515 USA</p> <p>Tel: +1 630 963 7070 Fax: +1 630 963 0109 info@ccontrols.com</p>	<p>China Contemporary Controls (Suzhou) Co. Ltd 19F, Metropolitan Towers, No.199 Shishan Road, Suzhou New District, 215009 China</p> <p>Tel: +86 512 68095866 Fax: +86 512 68093760 info@ccontrols.com.cn</p>	<p>United Kingdom Contemporary Controls Ltd 14 Bow Court Fletchworth Gate Coventry CV5 6SP United Kingdom</p> <p>Tel: +44 (0)24 7641 3786 Fax: +44 (0)24 7641 3923 info@ccontrols.co.uk</p>	<p>Germany Contemporary Controls GmbH Fuggerstraße 1 B 04158 Leipzig Germany</p> <p>Tel: +49 341 520359 0 Fax: +49 341 520359 16 info@ccontrols.de</p>
www.ccontrols.com			