

YASKAWA

INVERTER SERIES HIGH PERFORMANCE VECTOR CONTROL A1000



EN

DE

A1000
A1000
A1000
A1000

A1000

YASKAWA A1000 HIGH PERFORMANCE DRIVE

Contents

- ▶ **Page 2**
Experience & Innovation
A leader in Inverter Drives technology
Main Features
- ▶ **Page 3**
Customize Your Drive
- ▶ **Page 4/5**
Permanent Magnet Motor Control
- ▶ **Page 6/7**
Safety Features & Communication
- ▶ **Page 8/9**
Easy start-up and reliable operation
- ▶ **Page 10/11**
Drive Design & Features
- ▶ **Page 12**
Efficiency & Environment
- ▶ **Page 13**
Specifications
- ▶ **Page 14**
Connection Diagram
- ▶ **Page 15 - 17**
Dimensions
- ▶ **Page 18**
Options
- ▶ **Page 19**
Ratings & Type Descriptions

Experience & Innovation

For more than 100 years YASKAWA has been manufacturing and supplying mechatronic products for machine building and industrial automation. Its standard products as well as tailor-made solutions are famous and have a high reputation for outstanding quality and durability.

A Leader in Inverter Drives Technology

YASKAWA is the leading global manufacturer of inverter drives, servo drives, machine controllers, medium voltage inverters, and industrial robots. Founded in 1915, YASKAWA has been a pioneer in motion control and drive technology, launching product innovations, which optimise the productivity and efficiency of both machines and systems.

Today YASKAWA produces more than 1.9 million inverters per year. Considering this, YASKAWA is probably the biggest inverter manufacturer in the world.

With the A1000, YASKAWA continues its tradition of developing innovative solutions in drive technology. The A1000 provides remarkable advantages through excellent motor drive performance, environmental benefits and energy savings as well as many user orientated operational features. Moreover, the A1000 offers advanced characteristics that are included as standard.

A1000 Main Features:

- ▶ **Excellent motor drive performance:**
A1000 is a premium inverter drive running not only induction motors, but also PM motors (open and closed loop) with full torque at zero speed
- ▶ **Built-in functional safety features:**
The implemented Safe Torque Off (STO) function significantly improves machine safety and reliability and provides substantial cost reduction potentials
- ▶ **Optimized machine efficiency:**
Advanced energy-saving control technology which improves efficiency and machine productivity in combination with induction and PM motor operation
- ▶ **Easy integration of PLC functionality:**
DriveWorksEZ creates a custom drive functionality with just some mouse clicks and by fast and intuitive programming
- ▶ **Easy and time-saving start-up:**
A1000 automatically sets parameters needed for major applications and provides a full text display (8 languages)
- ▶ **Space saving and compact set-up:**
Outstanding power to size ratio and gap-less side-by-side installation reduce the mounting space to a minimum
- ▶ **Reliable Operation:**
Long life design for 10 years of maintenance-free operation

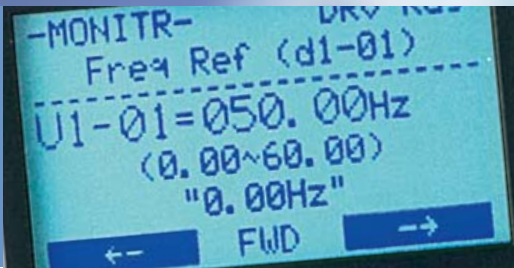

Permanent Magnet Motor Control

- ▶ Open loop position control without Encoder
- ▶ 200% rated torque at 0 rpm

Safety Features & Communication

- ▶ Functional Safety: A1000 provides Safe Torque Off (STO) in compliance with EN ISO 13849-1, Cat. 3, PLd, IEC/EN61508 SIL2
- ▶ External Device Monitor (EDM) to Observe the STO Function Status

Easy Start-up & Reliable Operation

- ▶ Application Parameter Presets
- ▶ Screwless Removable Control Terminal with Parameter Backup
- ▶ Online Auto-Tuning for Motor Parameter
- ▶ Tuning of the Speed Loop according to Load
- ▶ Parameter Copy and Backup Function
- ▶ Engineering Tool DriveWizard Plus for Parameter Management
- ▶ Application SW Library
- ▶ Performance Life Diagnostics for all major inverter components

Drive Design & Functions

- ▶ Extremely compact
- ▶ Space saving Side-by-Side Mounting
- ▶ Dual Rating for Cost & Space Saving
- ▶ Long Performance Life

Efficiency & Environment

- ▶ Advanced Energy Saving Functionality
- ▶ Unique PWM function reduces audible noise.
- ▶ Minimum Power Loss in Normal Duty Rating

Protective Design

A variety of protective designs are available to reinforce the drive against moisture, dust, oil mist, vibration, corrosive sulfur gas, conductive particles, and other harsh environments.

- ▶ A1000 IP54 Ready flange mounted with heat sink on the back bringing heat loss out of the panel for small sized custom panels with high degree of ingress protection
- ▶ A1000 IP54 Wall Mount for decentralized installation
- ▶ A1000 Floor Standing Panels (90 - 355 kW) configurable



A1000 IP54 Ready



A1000 IP54 Wall Mount



A1000 Floor Standing Panel



Advanced Motor Control

Advanced Drive Technology

- ▶ Capable of driving different types of motor. A1000 runs not only induction motors, but also synchronous motors like IPM*¹ and SPM*² motors with high performance open and closed loop vector control.
- ▶ Minimize equipment needed for your business by using the same drive to run induction and synchronous motors.

*1 Interior Permanent Magnet Motor
(Motors with permanent magnets inserted into the rotor)
*2 Surface Mounted Permanent Magnet Motor
(Motors with permanent magnets mounted on the surface of the rotor)

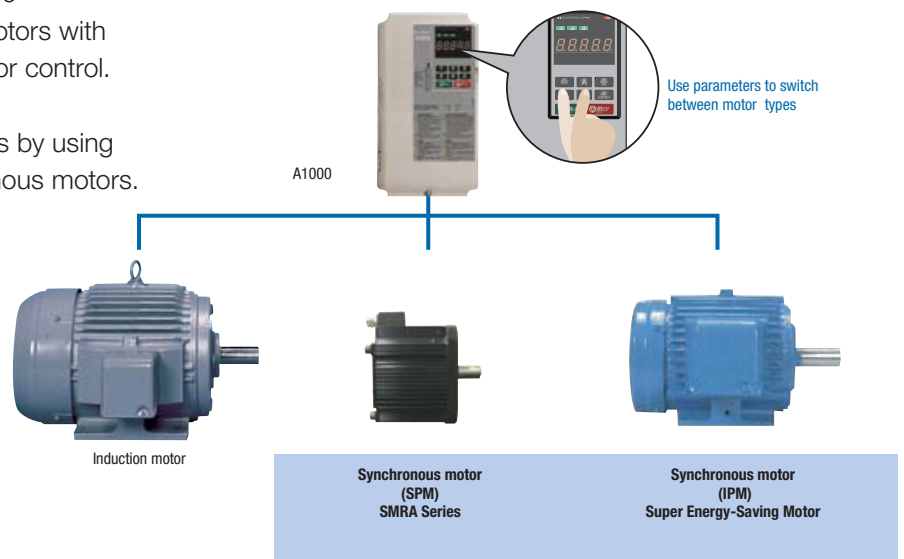

Positioning Capability without External Devices

- ▶ Use an IPM motor to perform position control – without motor feedback. Electrical saliency in IPM motors makes it possible to detect speed, direction and rotor position without the use of external feedback devices.
- ▶ Positioning functionality without a PLC. Visual programming in DriveWorksEZ eliminates the need for external controllers by giving the user the power to create customized functions such as position control.

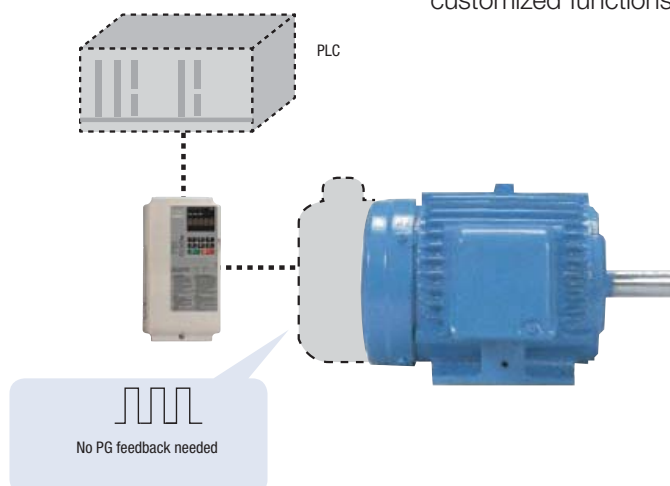



New Auto-Tuning Features

- ▶ Auto-Tuning features optimize drive parameters for operation with induction motors as well as synchronous motors to achieve the highest performance levels possible.
- ▶ Optimizing not only the drive and motor performance, but also automatically adjusts settings relative to the connected machinery.
- ▶ New Auto-Tuning methods.
A1000 continuously analyzes changes in motor characteristics during operation for highly precise speed control.

Tuning the Motor	
Rotational Auto-Tuning	Applications requiring high starting torque, high speed, and high accuracy.
Stationary Auto-Tuning	Applications where the motor must remain connected to the load during the tuning process.
Line-to-Line Resistance Auto-Tuning	For tuning after the cable length between the motor and drive has changed, or when motor and drive capacity ratings differ.
Energy-Saving Auto-Tuning	For running the motor at top efficiency all the time.

Tuning the Load	
ASR* Tuning	Perfects responsiveness relative to the machine. Until now, this tuning procedure was fairly time consuming to set.
Inertia Tuning	Optimizes the drive's ability to decelerate the load. Useful for applications using Kinetic Energy Buffering Function and Feed Forward functions.

* Automatic Speed Regulator

Powerful Torque Characteristics

- ▶ Powerful torque at 0 Hz, without sensors or feedback devices.
Until recently, sensorless control has been out of reach for synchronous motors. Now A1000 provides powerful starting torque algorithm without relying on pole sensors or motor feedback.
- ▶ High-performance current vector control achieves powerful starting torque with an induction motor.

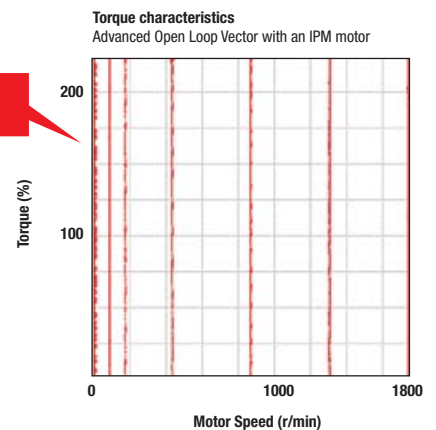

Synchronous Motor	
Advanced Open Loop Vector for PM motors	200% rated torque at 0 r/min*, speed range of 1:100*
Closed Loop Vector Control for PM motors	200% rated torque at 0 r/min, speed range of 1:1500

* only IPM motor

Induction Motor	
Open Loop Vector Control	200% rated torque at 0.3 Hz*, speed range of 1:200
Closed Loop Vector Control	200% rated torque at 0 r/min*, speed range of 1:1500

* Proper output torque depends on matching drive and motor capacity.



Safety Features & Communication

Power Loss & Recovery

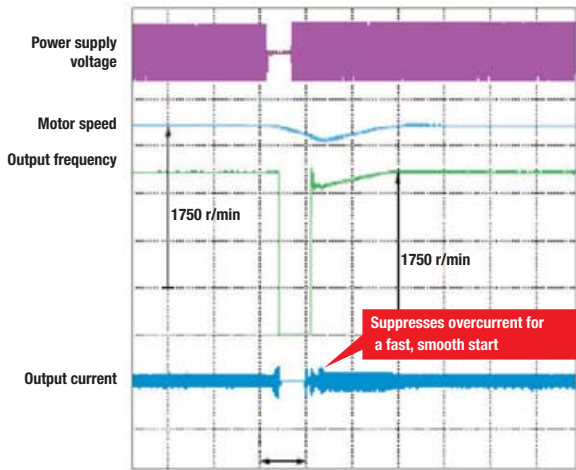

Speed Search
Easily find the speed of a coasting motor for a smooth restart.

Applications
Perfect for fans, blowers and other rotating, fluid-type applications.

- ▶ A1000 offers two ways to handle momentary power loss
- ▶ A1000 is capable of handling momentary power loss with sensorless control for induction motors as well as for synchronous motors.
- ▶ A1000 lets you ride through a power loss for up to 2 seconds.*

* Option available for certain models.

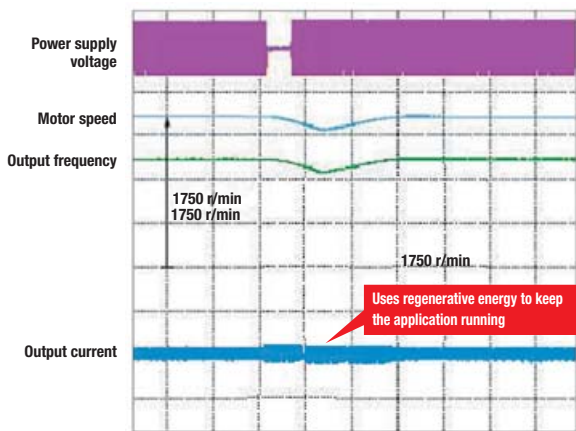

Kinetic Energy Buffering Ride-Through
Keep the motor running without allowing it to coast.

Applications
Should a power outage occur, A1000 can bring the application to controlled stop quickly using the Kinetic Energy Buffering function.

Highly recommended for film lines, textile machinery, and other applications requiring continuous operation.

Note: Separate sensor to detect power loss are required.



Safety Features as a Standard

- ▶ A1000 provides Safe Torque Off (STO) in compliance with EN ISO 13849-1, Cat. 3, PLd, IEC/EN61508 SIL2
- ▶ An External Device Monitor (EDM) function has also been added to monitor the safety status of the drive.

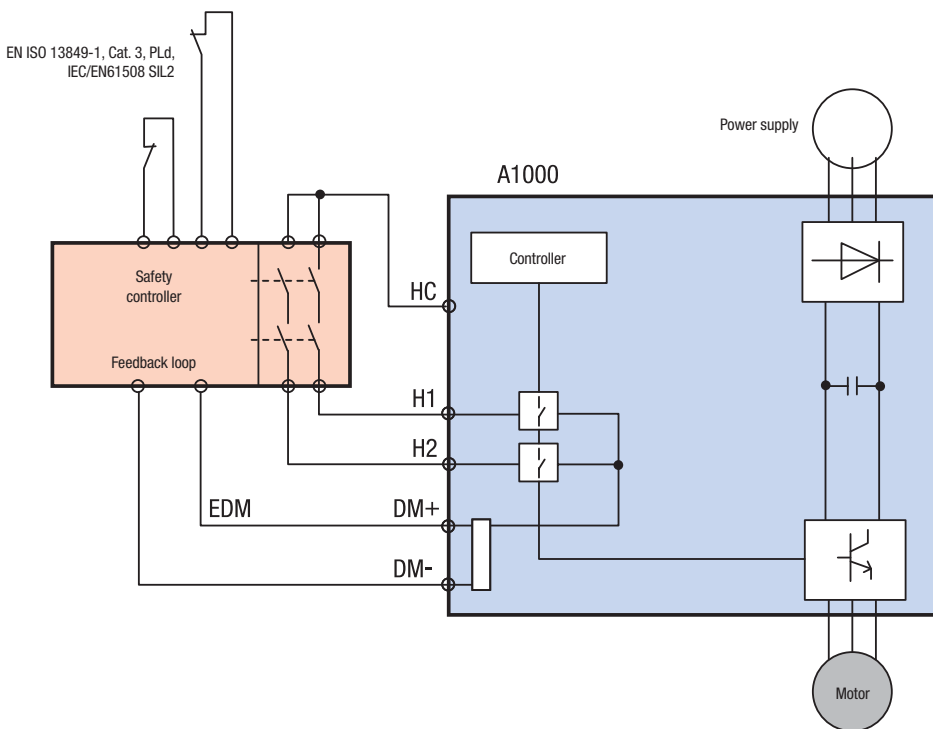

All Major Serial Communication Protocols

- ▶ RS-422/485 (MEMOBUS/Modbus at 115.2 kbps) standard on all models.
- ▶ Option cards available for all major fieldbuses used across the globe:



* Registered trademarks of those companies.



Easy start-up and reliable operation

Application Parameter Presets

- ▶ A1000 automatically sets parameters needed for major applications. Selecting the appropriate application optimizes the drive for top performance, while saving time for set up.

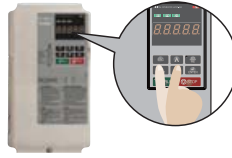
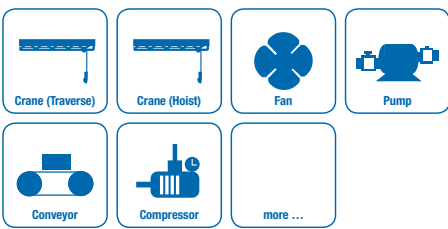

Setting	Setting
00	General-purpose
01	Water Supply Pump
02	Conveyor
03	Exhaust Fan
04	HVAC Fan
05	Air Compressor
06	Crane (Hoist)
07	Crane (Traverse)

Parameters are programmed automatically

A1-02	Control mode selection
C1-01	Accel Time 1
C1-02	Decel Time
C6-01	ND/HD Selection

Example using Application Presets

Selecting "Conveyor" optimizes parameter settings so the drive is ready to start your conveyor application immediately

Removable Terminal Block with Parameter Backup

- ▶ The first terminal board with a Parameter Backup Function. The terminal block's ability to save parameter setting data makes it easy to get the application back online in the event of a failure requiring drive replacement.

A1000 Terminal Block



Parameter		
Name	Number	Setting
ND/HD	C6-01	1
Control Mode	A1-02	0
Frequency Reference Selection	b1-01	1
Run Command Selection	b1-02	1

Parameter Copy Function

- ▶ All standard models are equipped with a Parameter Copy Function that allows parameter settings to be easily copied from the drive or uploaded for quick setup using the operator.
- ▶ A USB Copy Unit is also available as an even faster, more convenient way to back up settings and instantly program the drive.





DriveWorksEZ – Customise Your Drive

- ▶ DriveWorksEZ visual programming tool. Simply drag and drop icons to customize your drive. Create special sequences and detection functions, then load them onto the drive.

Program a customized sequence

- ▶ Example:
Sensorless positioning control function

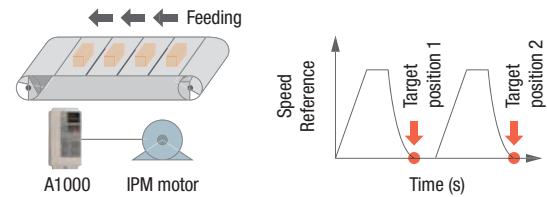

Create customized detection features

- ▶ Example:
Machine weakening analysis using torque pulse detection

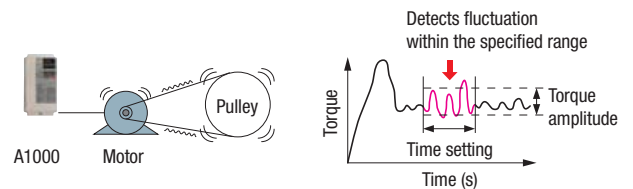

DriveWorksEZ solution examples

- ▶ Washing machine unbalance control
- ▶ Spindle orientation
- ▶ Electronic line shaft
- ▶ Programmable current limit pattern

Engineering Tool DriveWizard Plus

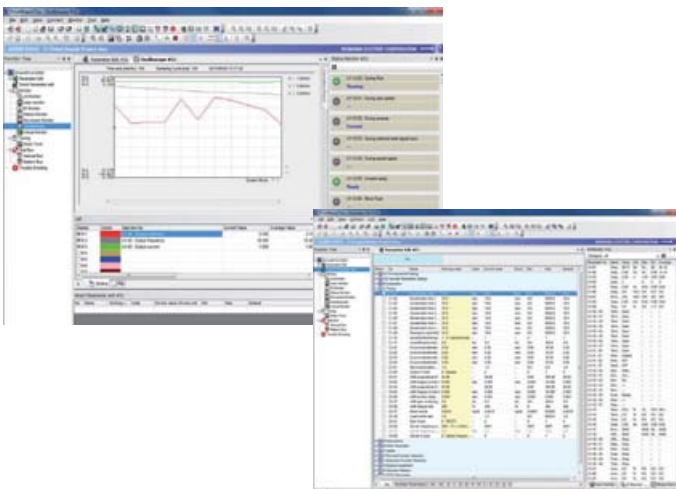

Manage the unique settings for all your drives right on your PC. An indispensable tool for drive setup and maintenance. Edit parameters, access all monitors, create customized operation sequences, and observe drive performance with the oscilloscope function.

- ▶ Convenient PC-based drive-setup, monitoring and diagnostic functions
- ▶ Built-in scope function
- ▶ Automatic parameter conversion from older series drives
- ▶ Online and offline parameter editing



Drive Design & Features

Even More Compact

- ▶ YASKAWA continues to make applications even smaller by combining the compact designed drive with the light, efficient design of a synchronous motor.
- ▶ Use Side-by-Side installation for an even more compact setup.
- ▶ Finless models available*.

* Coming soon

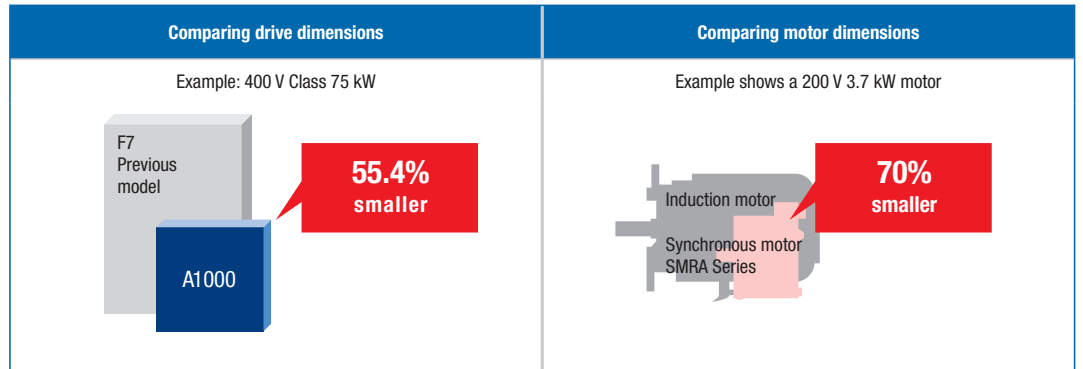

Dual Rating for Cost & Space Saving

- ▶ Each drive lets the user choose between Normal Duty or Heavy Duty operation. Depending on the application, A1000 can run a motor an entire frame size larger than our previous model.

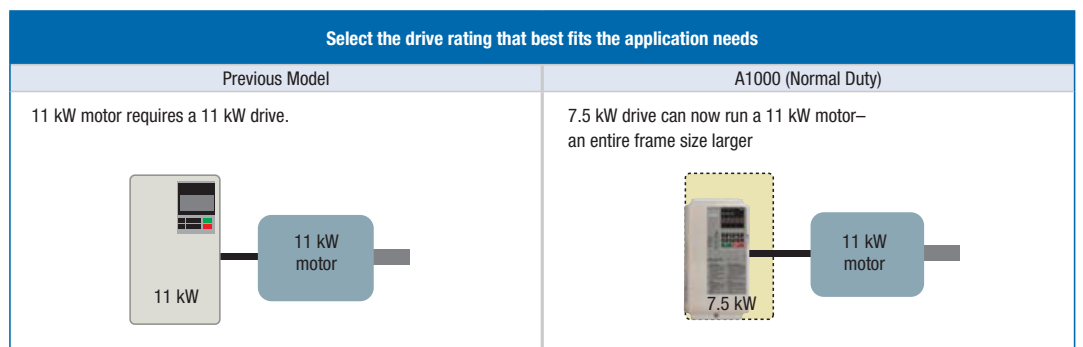

Dual Ratings in A1000

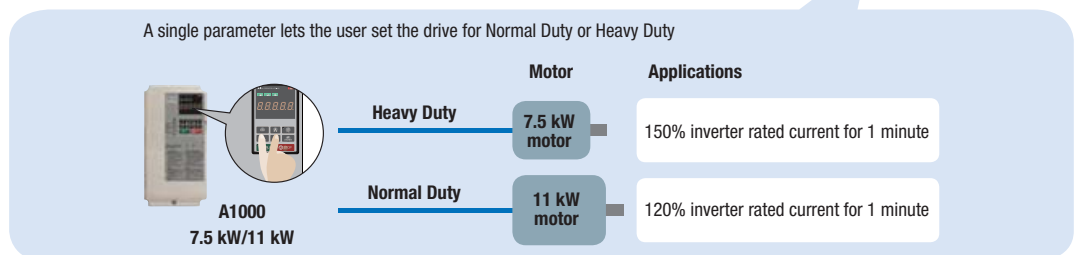

Note: Always select a drive with a current rating greater than the motor rated current.



Long Performance Life

- ▶ Designed for 10 years of maintenance-free operation. Cooling fan, capacitors, relays, and IGBTs have been carefully selected and designed for a life expectancy up to ten years.*



* Assumes the drive is running continuously for 24 hours a day at 80% load with an ambient temperature of 40°C.

Performance Life Monitors

- ▶ YASKAWA's latest drive series is equipped with performance life monitors that notify the user of part wear and maintenance periods to prevent problems before they occur.

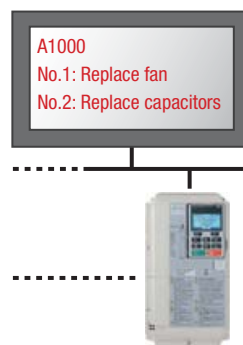

Operator Display	Corresponding Component
LT-1	Cooling fan
LT-2	Capacitors
LT-3	Inrush prevention relay
LT-4	IGBTs

Drive outputs a signal to the control device indicating components may need to be replaced

Variety of Braking Functions

- ▶ Overexcitation deceleration capabilities bring the motor to a quick stop without the use of a braking resistor.
- ▶ All models up to 30 kW (HD) are equipped with a braking transistor for even more powerful braking options by just adding a braking resistor.

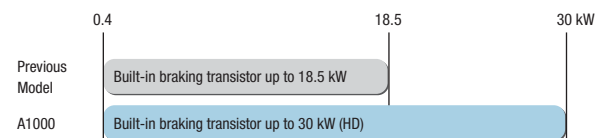

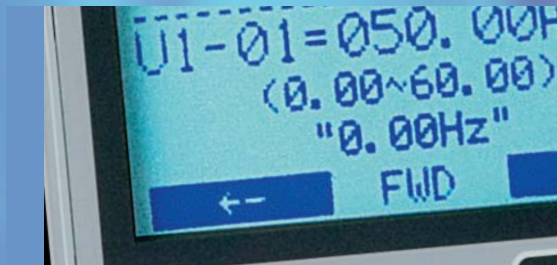

Efficiency & Environment

Energy Saving

- ▶ Loaded with advanced energy-saving control technology. Energy-Saving control makes highly efficient operation possible with an induction motor.
- ▶ Amazing energy saving with a synchronous motor. Combining the high efficiency of a synchronous motor along with A1000's Energy-Saving control capabilities allows for unparalleled energy saving.

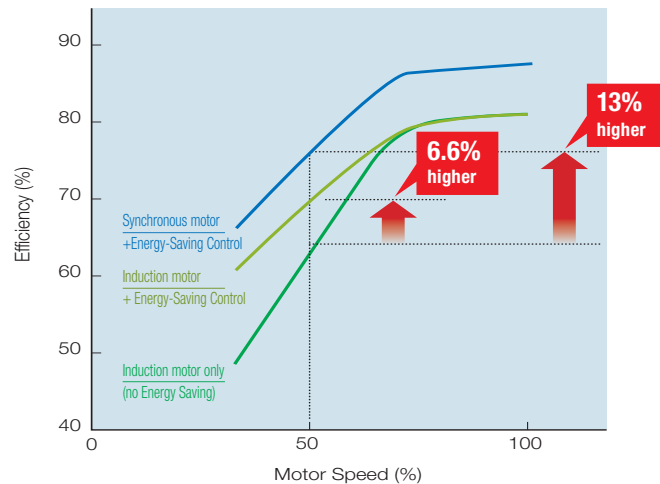

Conditions:
 Annual energy savings for an HVAC fan application running 100 3.7 kW motors. Electric costs of 8 cents/kWh*, Average industrial electric costs in Europe

Examples of energy saving with A1000 and PM Motor		
	Power consumption	Electrical costs
A Induction motor + A1000	1,903,100 kWh	€ 152,300
B IPM motor + A1000	1,754,600 kWh	€ 140,400
Annual savings on energy costs: [A] vs. [B]	148,500 kWh	€ 11,900
Annual reduction in CO ₂	148,500 kWh x 0.555 ÷ 1,000 =	82.4 tons!
Assumes 1 kW of power consumed creates 0.555 kg/kWh of CO ₂		

Total Energy Savings €11,900

Efficiency with energy saving function
 Example shows a 200 V 4.0 kW drive in a fan or pump application

Noise Reduction

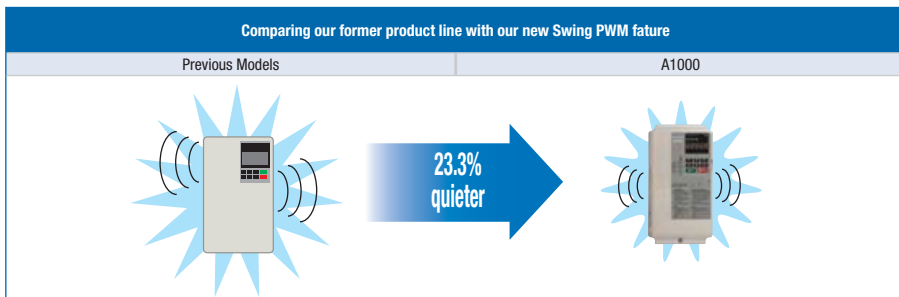

Note:
 Calculated by comparing peak values during noise generation

- ▶ A1000 uses YASKAWA Swing PWM function to suppress electromagnetic and audible motor noise, creating a more peaceful environment.



Standard Specifications

Item	Specifications
Control Method	V/f Control, V/f Control with PG, Open Loop Vector Control, Closed Loop Vector Control, Open Loop Vector for PM, Closed Loop Vector for PM, Advanced Open Loop Vector for PM
Frequency Control Range	0.01 to 400 Hz
Frequency Accuracy (Temperature Fluctuation)	Digital reference: within $\pm 0.01\%$ of the max. output frequency (-10 to $+40^{\circ}\text{C}$) Analog reference: within $\pm 0.1\%$ of the max. output frequency ($25^{\circ}\text{C} \pm 10^{\circ}\text{C}$)
Frequency Setting Resolution	Digital reference: 0.01 Hz Analog reference: 0.03 Hz / 60 Hz (11 bit)
Output Frequency Resolution	0.001 Hz
Frequency Setting Signal	-10 to $+10$ V, 0 to $+10$ V, 4 to 20 mA, Pulse Train
Starting Torque	150%/3 Hz (V/f Control and V/f Control with PG), 200%/0.3 Hz*1 (Open Loop Vector Control), 200%/0 r/min ⁻¹ (Closed Loop Vector Control, Closed Loop Vector Control for PM, and Advanced Open Loop Vector Control for PM), 100%/5% speed (Open Loop Vector Control for PM)
Speed Control Range	1:1500 (Closed Loop Vector Control and Closed Loop Vector for PM) 1:200 (Open Loop Vector Control) 1:40 (V/f Control and V/f Control with PG) 1:20 (Open Loop Vector for PM) 1:100 (Advanced Open Loop Vector for PM)
Speed Control Accuracy	$\pm 0.2\%$ in Open Loop Vector Control ($25^{\circ}\text{C} \pm 10^{\circ}\text{C}$) ² , 0.02% in Closed Loop Vector Control ($25^{\circ}\text{C} \pm 10^{\circ}\text{C}$)
Speed Response	10 Hz in Open Loop Vector ($25^{\circ}\text{C} \pm 10^{\circ}\text{C}$), 50 Hz in Closed Loop Vector Control ($25^{\circ}\text{C} \pm 10^{\circ}\text{C}$) (excludes temperature fluctuation when performing Rotational Auto-Tuning)
Torque Limit	All Vector Control allows separate settings in four quadrants
Accel/Decel Time	0.00 to 6000.0 s (4 selectable combinations of independent acceleration and deceleration settings)
Braking Torque	Drives of 200/400 V 30 kW or less have a built-in braking transistor. 1. Short-time decel torque ³ : over 100% for 0.4/ 0.75 kW motors, over 50% for 1.5 kW motors, and over 20% for 2.2 kW and above motors (over excitation braking/High-Slip Braking: approx. 40%) 2. Continuous regen. torque: approx. 20% (approx. 125% with dynamic braking resistor option ⁴ : 10% ED, 10s, internal braking transistor)
V/f Characteristics	User-selected programs and V/f preset patterns possible
Main Control Functions	Torque control, Droop control, Speed/torque control switching, Feedforward control, Zero-servo control, Momentary power loss ride-thru, Speed search, Over torque detection, Torque limit, 17-step speed (max), Accel/decel time switch, S-curve accel/decel, 3-wire sequence, Auto-tuning (rotational, stationary), Online tuning, Dwell, Cooling fan on/off switch, Slip compensation, Torque compensation, Frequency jump, Upper/lower limits for frequency reference, DC injection braking at start and stop, Overexcitation braking, High slip braking, PID control (with sleep function), Energy saving control, MEMOBUS comm. (RS-485/422 max, 115.2 kbps), Fault restart, Application presets, DriveWorksEZ (customized function), Removable terminal block with parameter backup function...
Motor Protection	Motor overheat protection based on output current
Momentary Overcurrent Protection	Drive stops when output current exceeds 200% of Heavy Duty Rating
Overload Protection	Drive stops after 60 s at 150% of rated output current (Heavy Duty Rating) ⁵
Overvoltage Protection	200 V class: Stops when DC bus exceeds approx. 410 V, 400 V class: Stops when DC bus exceeds approx. 820 V
Undervoltage Protection	200 V class: Stops when DC bus exceeds approx. 190 V, 400 V class: Stops when DC bus exceeds approx. 380 V
Momentary Power Loss Ride-Thru	Immediately stop after 15 ms or longer power loss. Continuous operation during power loss of less than 2 s (standard) ⁶
Heatsink Overheat Protection	Thermistor
Braking Resistance Overheat Protection	Overheat sensor for braking resistor (optional ERF-type, 3% ED)
Stall Prevention	Stall prevention during acceleration/deceleration and constant speed operation
Ground Protection	Protection by electronic circuit ⁷
Charge LED	Charge LED remains lit until DC bus has fallen below approx. 50 V
Area of Use	Indoors
Ambient Temperature	-10 to $+50^{\circ}\text{C}$ (open chassis), -10 to $+40^{\circ}\text{C}$ (NEMA Type 1)
Humidity	95% RH or less (no condensation)
Storage Temperature	-20 to $+60^{\circ}\text{C}$ (short-term temperature during transportation)
Altitude	Up to 1000 meters (output derating of 1% per 100 m above 1000 m, max. 3000 m)
Shock	10 to 20 Hz: 9.8m/s^2 ; 20 to 55 Hz: 5.9m/s^2 for 200 V up to 45 kW and 400 V up to 75 kW, 2.0m/s^2 for 200 V, 55 to 110 kW and 400 V, 90 to 315 kW
Standards	CE, UL, cUL, RoHS, Germanischer Lloyd
Protection Design	IP00 open-chassis, IP20, NEMA Type 1 enclosure, IP54 Wall Mount, IP54 Ready, IP23/IP54 Floorstanding Panels

*1: Requires a drive with recommended capacity.

*2: Speed control accuracy may vary slightly depending on installation conditions or motor used. Contact YASKAWA for details.

*3: Instantaneous average deceleration torque refers to the torque required to decelerate the motor (uncoupled from the load) from the rated motor speed down to zero in the shortest time.

*4: If L3-04 is enabled when using a braking resistor or braking resistor unit, the motor may not stop within the specified deceleration time.

*5: Overload protection may be triggered at lower levels if output frequency is below 6 Hz.

*6: Varies in accordance with drive capacity and load. Drives with a capacity of smaller than 11 kW in the 200 V (model: CIMR-AC2A0056) or 400 V (model: CIMR-AC4A0031) require a separate Momentary Power Loss Recovery Unit to continue operating during a momentary power loss of 2 s or longer.

*7: Ground protection cannot be provided when the impedance of the ground fault path is too low, or when the drive is powered up while a ground fault is present at the output.



Connection Diagram

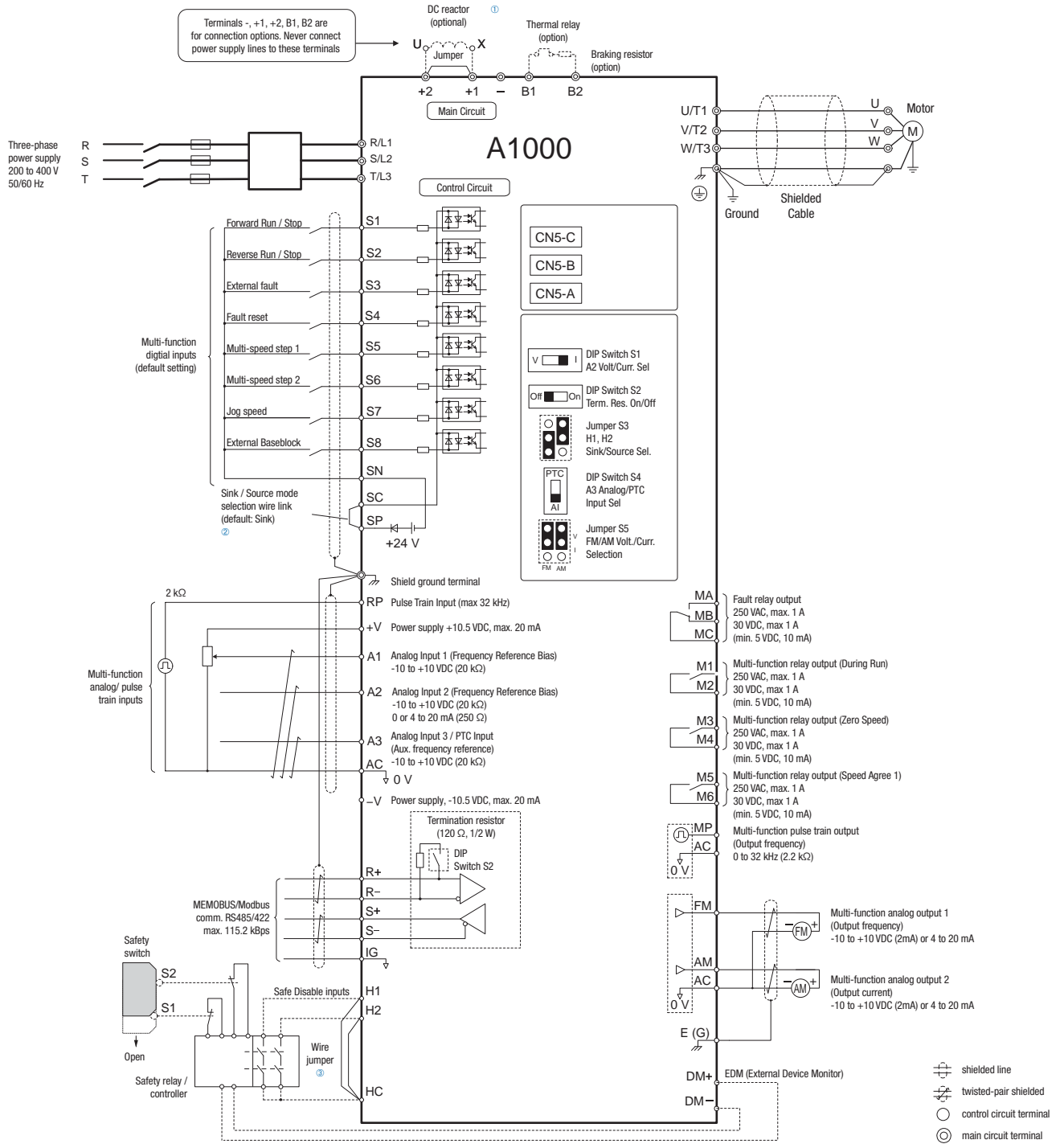

A1000

Dimensions

Enclosure IP00

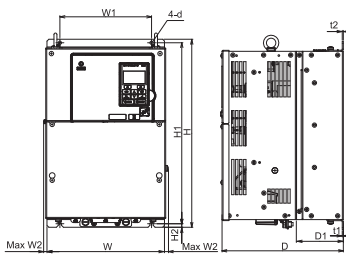

Fig. 1

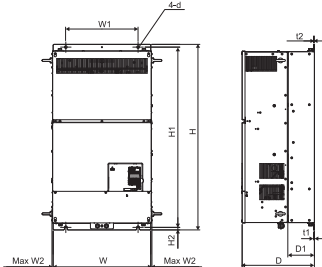

Fig. 2

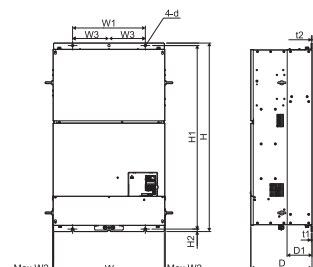

Fig. 3

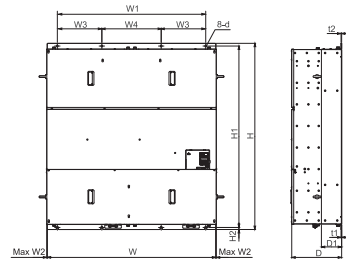

Fig. 4

200 V Class

Model CIMR-AC2A □□□□	Max. applicable motor capacity [kW]		Figure	Dimensions in mm										Weight (kg)	Cooling
	Normal Duty	Heavy Duty		W	H	D	W1	H1	H2	D1	t1	t2	d		
0110	30	22	Fig. 1	250	400	258	195	385	7.5	100	2.3	2.3	4-M6	21	Fan cooled
0138	37	30		275	450		220	435						25	
0169	45	37		325	550	283	260	535	37						
0211	55	45		450	705	330	325	680	12.5	110	3.2	3.2	4-M10	38	
0250	75	55												76	
0312	90	75		500	800	350	370	773	13	130	4.5	4.5	4-M12	80	
0360	110	90	96												
0415	110	110	99												

400 V Class

Model CIMR-AC4A □□□□	Max. applicable motor capacity [kW]		Figure	Dimensions in mm										Weight (kg)	Cooling
	Normal Duty	Heavy Duty		W	H	D	W1	H1	H2	D1	t1	t2	d		
0058	30	22	Fig. 1	250	400	258	195	385	7.5	100	2.3	2.3	4-M6	21	Fan cooled
0072	37	30		275	450		220	435						25	
0088	45	37		325	510	283	260	495	105	110	2.3	2.3	4-M6	36	
0103	55	45												41	
0139	75	55		450	705	330	325	680	12.5	130	3.2	3.2	4-M10	42	
0165	90	75												79	
0208	110	90	500	800	350	370	773	13	130	4.5	4.5	4-M12	96		
0250	132	110											102		
0296	160	132											107		
0362	185	160	Fig. 2	950	370	440	1110	15	135	4.5	4.5	4-M12	125		
0414	220	185											125		
0515	250	220	Fig. 3	670	1140	370	440	1110	15	150	4.5	4.5	4-M12	216	
0675	355	315	221												
0930	500	450	Fig. 4	1250	1380	370	1110	1345	15	150	4.5	4.5	4-M12	545	
1200	630	560												555	



Dimensions

Enclosure NEMA Type 1

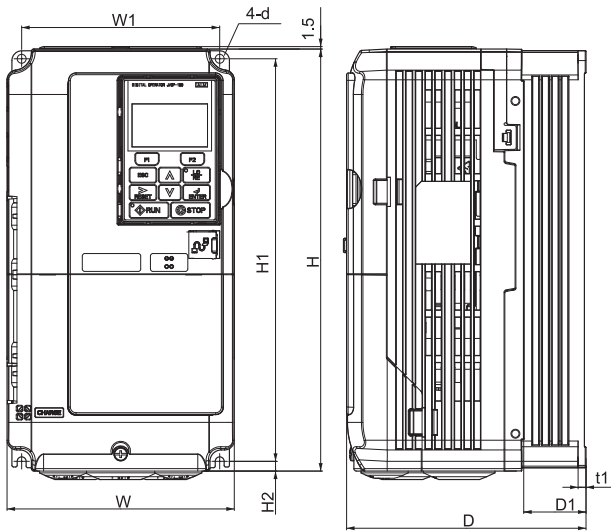

Fig. 1

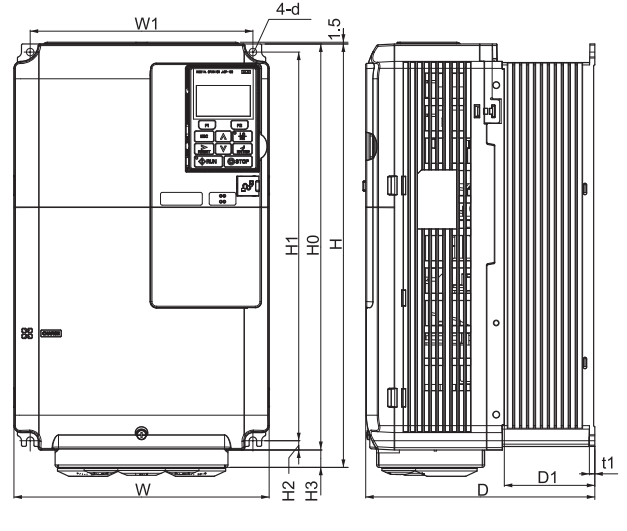

Fig. 2

200 V Class

Model CIMR-AC2A □□□□	Max. applicable motor capacity [kW]		Figure	Dimensions in mm												Weight (kg)	Cooling
	Normal Duty	Heavy Duty		W	H	D	W1	H0	H1	H2	H3	D1	t1	t2	d		
0004	0.75	0.4	Fig. 1	140	260	147	122	-	248	6	-	38	5	-	4-M5	3.1	Self cooling
0006	1.1	0.75				164						55				3.2	
0010	2.2	1.5				164						55				3.5	
0012	3	2.2				167						75				4.0	
0021	5.5	4.0		180	300	187	160	-	284	8	-	75	-	-	4-M6	5.6	Fan cooled
0030	7.5	5.5				197						78				8.7	
0040	11	7.5				192						78				9.7	
0056	15	11				192						78				9.7	
0069	18.5	15	Fig. 2	220	350	197	192	350	335	8	15	78	-	-	-	8.7	Fan cooled
0081	22	18.5				197										78	

400 V Class

Model CIMR-AC4A □□□□	Max. applicable motor capacity [kW]		Figure	Dimensions in mm												Weight (kg)	Cooling
	Normal Duty	Heavy Duty		W	H	D	W1	H0	H1	H2	H3	D1	t1	t2	d		
0002	0.75	0.4	Fig. 1	140	260	147	122	-	248	6	-	38	5	-	4-M5	3.2	Self cooling
0004	1.5	0.75				164						55				3.4	
0005	2.2	1.5				164						55				3.5	
0007	3	2.2				164						55				3.9	
0009	4.0	3				167						75				5.4	
0011	5.5	4.0				180						300				187	
0018	7.5	5.5		197	78		8.3										
0023	11	7.5		192	78		8.3										
0031	15	11		192	78		8.3										
0038	18.5	15		220	350	197	192	335	8	15	78	-	-	-	-	8.3	Fan cooled
0044	22	18.5	197			78										8.3	

Dimensions

Enclosure IP54 Ready

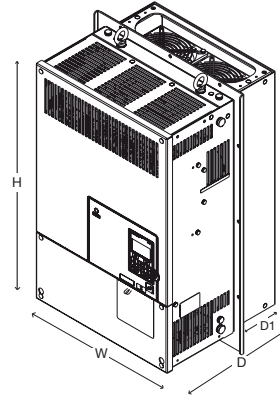

Model CIMR-AC4A □□□□	Current (AMP)		Power (kW)		Dimensions in mm				Weight
	HD	ND	HD	ND	W	H	D	D1	kg
0044WAA	39	44	18.5	22	275	402	197	75.6	11
0058WAA	45	58	22	30	300	455	275	102	21
0072WAA	60	72	30	37	325	505	275	102	25
0088WAA	75	88	37	45	370	565	283	105	36
0103WAA	91	103	45	55	370	565	283	105	36
0139WAA	112	139	55	75	370	565	285	110	41
0165WAA	150	165	75	90	370	565	285	110	42

Enclosure IP54 Wall Mount

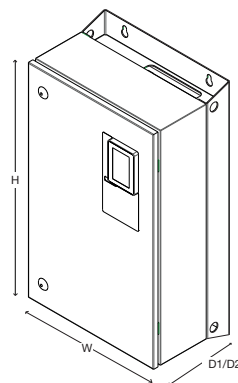

Model CIMR-AC4A □□□□	Current (AMP)		Power (kW)		Dimensions in mm				Weight
	HD	ND	HD	ND	W	H	D1	D2*	kg
0044TAA / ..0095*	39	44	18.5	22	400	700	260	292	35
0058TAA / ..0095*	45	58	22	30	465	750	300	331	50
0072TAA / ..0095*	60	72	30	37					55
0088TAA / ..0095*	75	88	37	45	555	950	325	375	74
0103TAA / ..0095*	91	103	45	55					85
0139TAA / ..0095*	112	139	55	75					
0165TAA / ..0095*	150	165	75	90					

* Version with mains switch



Options

Name	Purpose	Model	Model		
Input Noise Filter	Reduces noise from the line that enters into the drive input power system. Should be installed as close as possible to the drive. 400 V class: Filter of the manufacturer Block are used. Class C1 and footmounting up to 15 kW (HD), Class C2 and side mounting up to 110 kW (HD)	4A0002 □ AA	FB-40008A	4A0088 □ AA	FB-40105A
		4A0004 □ AA		4A0103 □ AA	
		4A0005 □ AA		4A0139 □ AA	FB-40170A
		4A0007 □ AA	4A0165 □ AA		
		4A0009 □ AA	FB-40014A	4A0208 □ AA	FB-40250A
		4A0011 □ AA		4A0250 □ AA	
		4A0018 □ AA	FB-40025A	4A0296 □ AA	FB-40414A
		4A0023 □ AA		4A0362 □ AA	
		4A0031 □ AA	FB-40044A	4A0414 □ AA	FB-40675A
		4A0038 □ AA		4A0515 □ AA	
4A0044 □ AA	FB-40060A	4A0675 □ AA	FB-41200A		
4A0058 □ AA		4A0930 □ AA			
4A0072 □ AA	FB-40072A	4A1200 □ AA			
AC Chokes	Reducing Harmonics		B06040 Series		
Analog input	Enables high-precision and high-resolution analog speed reference setting. <ul style="list-style-type: none"> Input signal level: -10 to +10 VDC (20 kΩ) 4 to 20 mA (500 Ω) Input channels: 3 channels, DIP switch for input voltage/input current selection Input resolution: Input voltage 13 bit signed (1/8192) Input current 1/6554 		AI-A3		
Digital Input	Enables 16-bit digital speed reference setting. <ul style="list-style-type: none"> Input signal: 16 bit binary, 2 digit BCD + sign signal + set signal Input voltage: +24 V (isolated) Input current: 8 mA Selectable Parameter: 8 bit, 12 bit, 16 bit 		DI-A3		
Communication interface unit	Allows control of the drive via a fieldbus network.	CANopen	SI-S3		
		CC-link	SI-C3		
		DeviceNet	SI-N3		
		EtherCat	SI-ES3		
		Ethernet/IP	SI-EN3		
		MECHATROLINK-2	SI-T3		
		Modbus TCP/IP	SI-EM3		
		Powerlink	SI-P3		
		PROFIBUS-DP	SI-EP3		
		PROFINET			
Analog monitor	Outputs analog signal for monitoring drive output state (output freq., output current etc.) <ul style="list-style-type: none"> Output resolution: 11 bit signed (1/2048) Output voltage: -10 to +10 VDC (non-isolated) Output channels: 2 channels 		A0-A3		
Digital output	Outputs isolated type digital signal for monitoring drive run state (alarm signal, zero speed detection, etc.). Output channel: Photo coupler 6 channels (48 V, 50 mA or less) Relay contact output 2 channels 250 VAC, 1 A or less 30 VDC, 1 A or less		DO-A3		
Open collector PG interface	For control modes requiring a PG encoder for motor feedback. <ul style="list-style-type: none"> Phase A, B, and Z pulse inputs (complementary type) PG frequency range: Approx. 50 kHz max. Pulse monitor output: Open collector, max. voltage: 24 V, max. current 30 mA Power supply output for PG: +12 V, max. current 200 mA 		PG-B3		
Line Driver PG interface	For control modes requiring a PG encoder for motor feedback. <ul style="list-style-type: none"> Phase A, B, and Z pulse (differential pulse) inputs (RS-422) PG frequency range: up to 300 kHz (approx.) Pulse monitor output: RS-422 Power supply output for PG: +5 V or +12 V, max. current 200 mA 		PG-X3		
LED Operator	Easy long distance reading		JVOP-182		
Braking Resistor	Used to shorten the deceleration time by dissipating regenerative energy through a resistor. (3% ED) (all models up to 3,7 kW)		ERF-150WJ series		
Braking Chopper Unit	Shortened deceleration time results when used with a Braking Transistor Unit.		CDBR series		
24 V Power Supply	Provides power supply for the control circuit and option boards. Note: Parameter settings cannot be changed when the drive is operating solely from this power supply.		PS-A10H PS-A10L		
USB Copy Unit (RJ-45/USB compatible plug)	<ul style="list-style-type: none"> Adapter for connecting the drive to the USB port of a PC Can copy parameter settings easily and quickly to be later transferred to another drive. 		JVOP-181		
LCD operator extension cable	Cable for connecting the LCD operator.		WV001: 1 m WV003: 3 m		

Note: contact the manufacturer in question for availability and specifications of non-YASKAWA products.



Ratings & Type Descriptions

Model Number Key

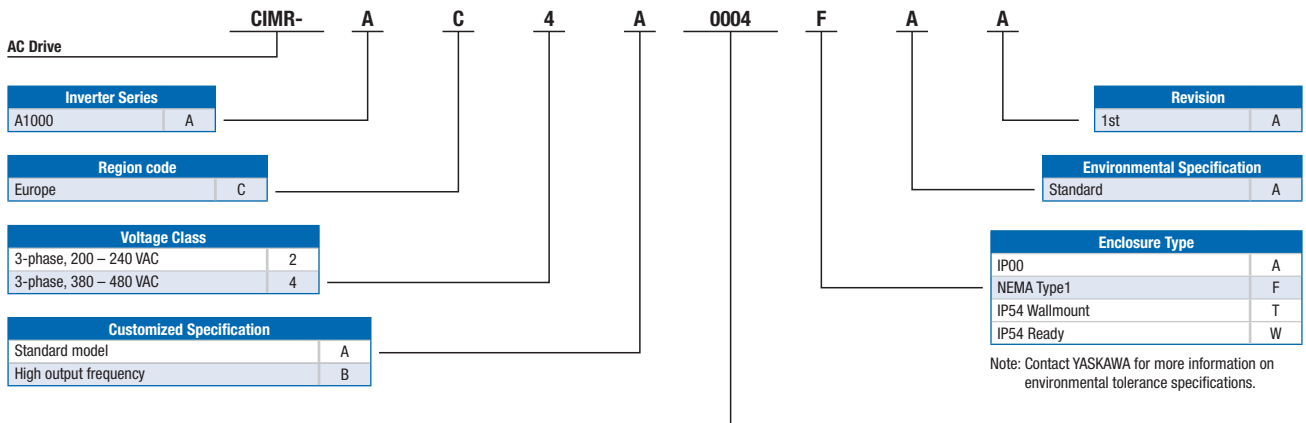

	200 V			
	Normal duty*1		Heavy duty	
	Rated output current [A]	Max. applicable motor*2 [kW]	Rated output current [A]	Max. applicable motor*2 [kW]
0004	3.5	0.75	3.2*3	0.4
0006	6	1.1	5*3	0.75
0010	9.6	2.2	8*3	1.5
0012	12	3	11*3	2.2
0021	21	5.5	17.5*3	4.0
0030	30	7.5	25*3	5.5
0040	40	11	33*3	7.5
0056	56	15	47*3	11
0069	69	18.5	60*3	15
0081	81	22	75*3	18.5
0110	110	30	85*3	22
0138	138	37	115*3	30
0169	169	45	145*4	37
0211	211	55	180*4	45
0250	250	75	215*4	55
0312	312	90	283*4	75
0360	360	110	346*4	90
0415	415	110	415*1	110

	400 V			
	Normal duty*1		Heavy duty	
	Rated output current [A]	Max. applicable motor*2 [kW]	Rated output current [A]	Max. applicable motor*2 [kW]
0002	2.1	0.75	1.8*3	0.4
0004	4.1	1.5	3.4*3	0.75
0005	5.4	2.2	4.8*3	1.5
0007	6.9	3	5.5*3	2.2
0009	8.8	4.0	7.2*3	3
0011	11.1	5.5	9.2*3	4.0
0018	17.5	7.5	14.8*3	5.5
0023	23	11	18*3	7.5
0031	31	15	24*3	11
0038	38	18.5	31*3	15
0044	44	22	39*3	18.5
0058	58	30	45*3	22
0072	72	37	60*3	30
0088	88	45	75*5	37
0103	103	55	91*3	45
0139	139	75	112*4	55
0165	165	90	150*4	75
0208	208	110	180*4	90
0250	250	132	216*4	110
0296	296	160	260*4	132
0362	362	185	304*4	160
0414	414	220	370*4	185
0515	515	250	450*1	220
0675	675	355	605*1	315
0930	930	500	810*1	450
1200	1200	630	1090*1	560

*1: This value assumes a carrier frequency of 2 kHz. Increasing the carrier frequency requires a reduction in current.

*2: The motor capacity (kW) refers to a YASKAWA 4-pole, 60 Hz, 200 V motor or 400 V motor. The rated output current of the drive output amps should be equal to or greater than the motor rated current.

*3: This value assumes a maximum carrier frequency of 8 kHz. Increasing the carrier frequency requires a reduction in current.

*4: This value assumes a maximum carrier frequency of 5 kHz. Increasing the carrier frequency requires a reduction in current.

YASKAWA

YASKAWA Europe GmbH

Drives & Motion Division
Hauptstr. 185
65760 Eschborn
Germany

Tel: +49 6196 569-500
support@yaskawa.eu.com
www.yaskawa.eu.com

International Standards



Safety Standards

Safety Stop

RoHS Directive

RoHS Directive Stands for the EU directive on the Restriction of the Use of Certain Hazardous Substances in Electrical and Electronic Equipment