



NP785 Ultra Low Differential Pressure Transmitter

INSTRUCTION MANUAL V1.0x E





CE MARK

This is a Class A product. In a domestic environment, this product may cause radio interference in which case the user may be required to take adequate measures.

1	SAFETY ALERTS.....	3
2	PRESENTATION.....	4
3	IDENTIFICATION.....	5
3.1	DEVICE IDENTIFICATION.....	5
3.2	DEVICE MODEL.....	5
4	INSTALATION.....	6
4.1	MECHANIC INSTALATION.....	6
4.1.1	DIMENSION.....	7
4.2	ELECTRICAL INSTALLATION.....	7
4.2.1	RECOMMENDATIONS FOR INSTALLATION.....	7
4.2.2	SPECIAL PRECAUTION.....	7
4.2.3	ELECTRICAL CONNECTIONS.....	8
4.2.4	USB CONNECTION.....	8
5	CONFIGURATION.....	9
5.1	GENERAL CONFIGURATION.....	9
5.2	ALARM CONFIGURATION.....	9
5.3	ANALOG OUTPUT CONFIGURATION.....	10
6	USB INTERFACE.....	11
7	SERIAL COMMUNICATION.....	12
7.1	REGISTERS TABLE.....	12
8	NXPERIENCE SOFTWARE.....	20
8.1	INSTALLING NXPERIENCE.....	20
8.2	RUNNING NXPERIENCE.....	20
8.3	CONFIGURING WITH NXPERIENCE.....	20
8.3.1	GENERAL PARAMETERS.....	22
8.3.2	INPUT PARAMETERS.....	22
8.3.3	OUTPUT PARAMETERS.....	23
8.3.3.1	TRANSMISSION OUTPUT CONFIGURATION.....	23
8.3.3.2	ALARM OUTPUT CONFIGURATION.....	24
8.3.4	DIAGNOSTICS.....	25
8.3.5	FINALIZATION.....	26
9	TECHNICAL SPECIFICATION.....	27
10	WARRANTY.....	28

1 SAFETY ALERTS

The symbols below are used in the device and throughout this manual to draw the user's attention to important information related to device safety and use.

		
CAUTION Read the manual fully before installing and operating the device.	CAUTION OR HAZARD Risk of electric shock.	ATTENTION Material sensitive to static charge. Check precautions before handling.

All safety recommendations appearing in this manual must be followed to ensure personal safety and prevent damage to the instrument or system. If the instrument is used in a manner other than that specified in this manual, the device's safety protections may not be effective.

2 PRESENTATION

The **NP785 Ultra Low Differential Pressure Transmitter** uses a high precision differential pressure sensor and has the stability required to perform measurements in applications that require high sensitivity. It is a micro processed device with two communication interfaces: USB and RS485 via Modbus RTU protocol. The magnitude read by the sensor is provided through any of its interfaces, converted to a selected pressure unit from a set of options.

This equipment has a digital alarm output, which supports the configuration of the alarm condition, adjustable set points and custom timing, among other functions. Its transmission output can be configured to operate in the 0-10 V and 4-20 mA standards, with adjustable range within the sensor limits, and has adjustable behavior options in case of sensor error.

NXperience software offers a quick and intuitive way to configure of all equipment features. It is also possible to carry out the monitoring and obtain the diagnosis of the information downloaded.

The **NP785 Ultra Low Differential Pressure Transmitter** is suitable for use in HVAC applications such as environmental monitoring or climate control or environmental monitoring of industrial processes where high accuracy is required at low pressure ranges.

3 IDENTIFICATION

3.1 DEVICE IDENTIFICATION

The identification of the device model is described on its side label, together with information regarding its electrical connections and its serial number. Fig. 01 shows the information available in the device housing:

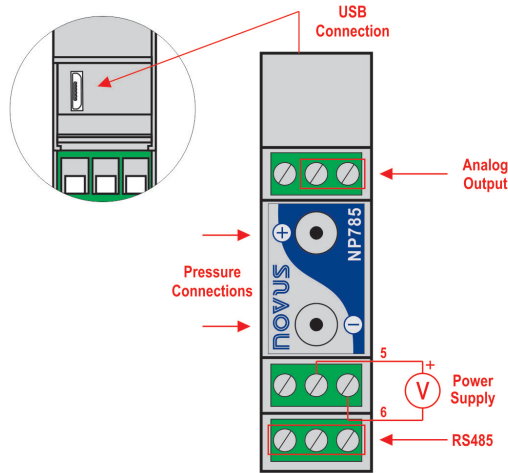

Fig. 01 – NP785 Ultra Low Differential Pressure Transmitter

3.2 DEVICE MODEL

In order to adapt to the most varied market needs, the **NP785 Ultra Low Differential Pressure Transmitter** line is available in two models:

- Model **NP785-05** of ± 5 mbar.
- Model **NP785-20** of ± 20 mbar.

Model	Minimal Pressure	Maximal Pressure	Unit	Burst Pressure	Standard Configuration
5 mbar	-5.000	5.000	mbar	± 200 mbar	x
	-72.52	72.52	mpsi		
	-2.007	2.007	in H ₂ O		
	-50.98	50.98	mm H ₂ O		
	-500.0	500.0	Pa		
20 mbar	-20.000	20.000	mbar	± 400 mbar	x
	-290.08	290.08	mpsi		
	-8.029	8.029	in H ₂ O		
	-203.94	203.94	mm H ₂ O		
	-2000.0	2000.0	Pa		

Table 01 – Model measuring range

4 INSTALATION

4.1 MECHANIC INSTALATION

The NP785 Ultra Low Differential Pressure Transmitter is designed to have its housing fixed to a 35 mm DIN rail, as shown in Fig. 02. The 35 mm DIN rail installation must be carried out after the device has been configured.

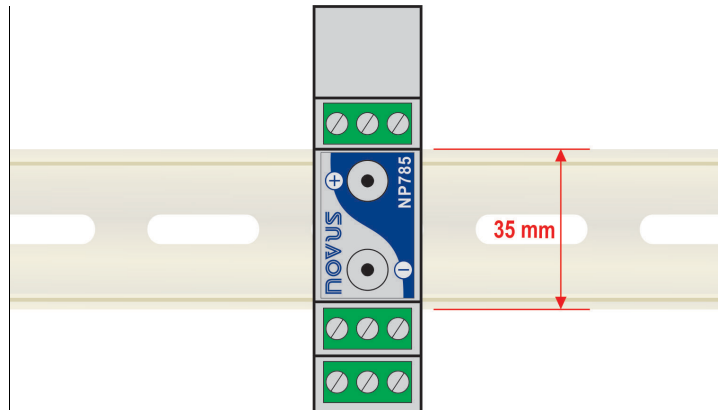

Fig. 02 – Mechanical installation

Installation recommendations:

- The pneumatic hoses must be installed after the device has been fitted to the 35 mm DIN rail.
- In order to avoid problems with condensation, the device must be installed above the point to be measured.
- The extension of the hoses does not affect the device accuracy. Very long hoses, however, can result in measurement delays.
- Hoses should not be bent or sharp curves should not be taken. Such actions may result in airflow interruption and possible sensor reading blockage.

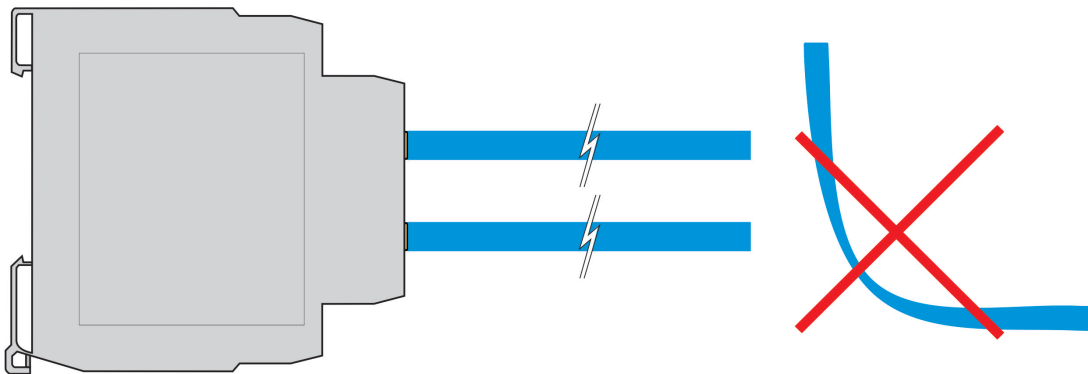

Fig. 03 – Hose handling



The hose do not come with the device.

Overpressure: Excessive pressure, which exceeds the NP785 Ultra Low Differential Pressure Transmitter capacity, can cause irreversible mechanical and electrical damage to the device. In order to avoid damaging the operator or the device installer, follow the installation instructions and use the appropriate protection and device.

4.1.1 DIMENSION

Fig. 04 shows the dimensions of the device:

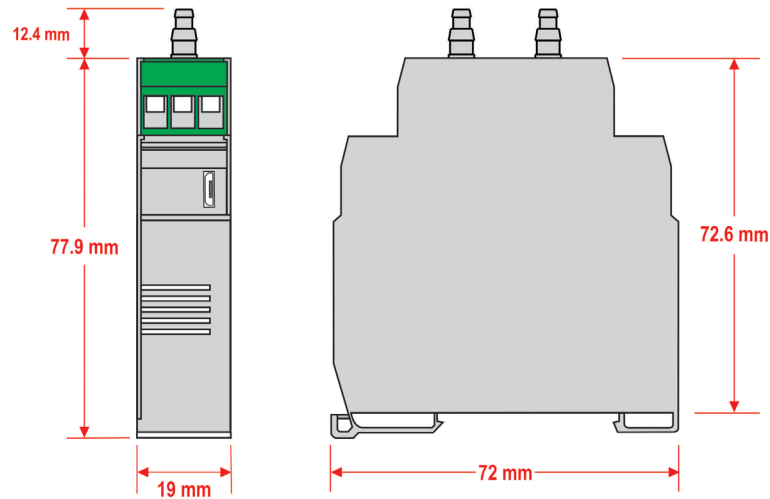

Fig. 04 – NP785 Ultra Low Differential Pressure Transmitter Dimension

4.2 ELECTRICAL INSTALLATION

4.2.1 RECOMMENDATIONS FOR INSTALLATION

- Signal conductors should run through the plant separately from the power supply and output conductors. If possible, in grounded conduits.
- The power supply for electronic instruments must come from an appropriate grid for instruments.
- RC FILTERS (noise suppressor) are recommended in contactor coils, solenoids, etc.
- In control applications, it's essential to consider what could happen when some part of the system fails. The device's internal devices do not ensure total protection.
- Grounding helps limit the effects of noise due to electromagnetic interference (EMI). Run the grounding connection by using the grounding bolt and the grounding plane before turning on the device.

4.2.2 SPECIAL PRECAUTION

Because it is an electronic module, the device needs some care when handling:

- Due to the risk of damage caused by static electricity and may occur if the electronic circuit is exposed, the device should not be opened.
- Pay close attention when connecting the wires.
- Remember to pass all wires through a cable clip before completing electrical connections.
- When closing the housing, the cover should be placed again properly, ensuring proper sealing for this device.



4.2.3 ELECTRICAL CONNECTIONS

Fig. 05 shows the device electrical connections:

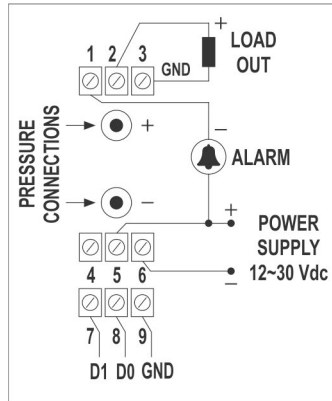

Fig. 05 – NP785 electrical connections

	Electrical Connection	Input
Output	1	ALARM
	2	OUT (Retransmission)
	3	GND
Power Supply	4	NC
	5	POWER
	6	GND
RS485	7	D1 (D)
	8	D0 (\bar{D})
	9	GND

Table 02 – Electrical connections

4.2.4 USB CONNECTION

The USB connection is used exclusively for the device diagnosis and configuration. The USB interface is on the **NP785 Ultra Low Differential Pressure Transmitter** side.

It is recommended that the device be configured before it is attached to the DIN rail.

For more information, check the [USB Interface](#) chapter.

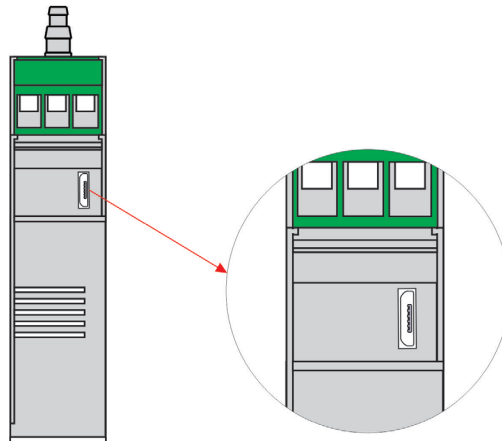

Fig. 06 – USB Cable connection

5 CONFIGURATION

The **NP785 Ultra Low Differential Pressure Transmitter** is configurable by any of its interfaces. Due to the ease of use of the interface, it is recommended to configure via USB using the **NXperience** software, but the device can also be configured via Modbus RTU by writing directly in their configuration registers.

The description of the device registers, together with the configuration tables, can be found in the [Serial Communication](#) chapter.

5.1 GENERAL CONFIGURATION

The purchase of the pressure value is done in digital analogue analysis solutions of the internal sensor of the device. You can select the pressure unit to be used from the following options: mbar, mpsi, in H₂O, mm H₂O or Pa. Changes in this setting cause transmission limits and alarm set points to be reverted to the default values, which are the operating limits of the device.

The device also has an **Offset** function and an internal digital filter for treatment of the measured signal. An offset value can be set, which will be described on the selected pressure unit, to make small adjustments to the output value. The digital filter allows you to set a time interval, in seconds, to reduce the occurrence of noise effects and peaks of pressure over a faster response.

It is also possible to configure the Modbus RTU communication parameters, such as Baud Rate, parity and slave address of the device.

For purposes of differentiation between units of the same model, an identifier can be configured in the device.

For testing purposes, the device supports forcing differential pressure measurement, analog output and alarm output. For each of these cases, you can configure a value to be forced and enable or disable the forcing.

5.2 ALARM CONFIGURATION

The **NP785 Ultra Low Differential Pressure Transmitter** has a digital alarm output. The digital output will be activated whenever an alarm situation is satisfied, except in particular cases defined by some of its settings.

You can configure the alarm operation mode, high and low set points, hysteresis value, state transition timers, error condition and initial blocking.

Alarm configuration can be performed using the **NXperience** software (see the [Output Parameter](#) section), allowing different modes of operation:

- **Off:** No alarm situation is active.
- **Sensor Error:** While there is some error reading the sensor, the alarm output will remain on.
- **Below Lower Setpoint:** The alarm output will be triggered when the current pressure is lower than the lower set point. To exit the alarm condition, the differential pressure must be greater than the lower set point plus the hysteresis value.
- **Above Higher Setpoint:** The alarm output will be triggered when the differential pressure is higher than the upper set point. To exit the alarm condition, the differential pressure must be lower than the lower set point minus the hysteresis value.
- **Intra-range:** The alarm output will be activated when the differential pressure is higher than the lower set point and lower than the upper set point. To exit the alarm condition, the differential pressure must be greater than the upper set point plus the hysteresis value or lower than the lower set point minus the hysteresis value.
- **Extra-range:** The alarm output will be activated when the differential pressure is higher than the set point higher or lower than the lower set point. To exit the alarm condition, the differential pressure must be less than the upper set point minus the hysteresis value and higher than the lower set point plus the hysteresis value.

In addition to the alarm operation modes, other parameters, which do not apply to the Sensor Error mode, can be configured to refine the behavior of the alarm output:

- **Initial Blocking:** This parameter determines the use of the alarm output lock soon after the device is started. After initialization, a non-alarm condition is required for the alarm output to be enabled.
- **Error Condition:** The status of this parameter determines whether the alarm output will remain on or off in case of sensor failure.
- **Hysteresis:** This parameter stores the pressure value that, with the values of the set points, determines the limit value to leave the alarm situation. **Fig. 07** shows the conditions for alarm activation and deactivation.

The alarm output can be timed by means of the **Time On** and **Time Off** parameters. For a given state transition to occur, the device must remain in the new state for a period of time equal to the one configured in the respective transition parameter. These values are initialized to 0 by default.

Extra-range mode is the default mode of alarm output. The default values of the set points, in turn, are the operating limits of the device. Any changes in the pressure unit configuration readjust the values of the set points to the operating limits.

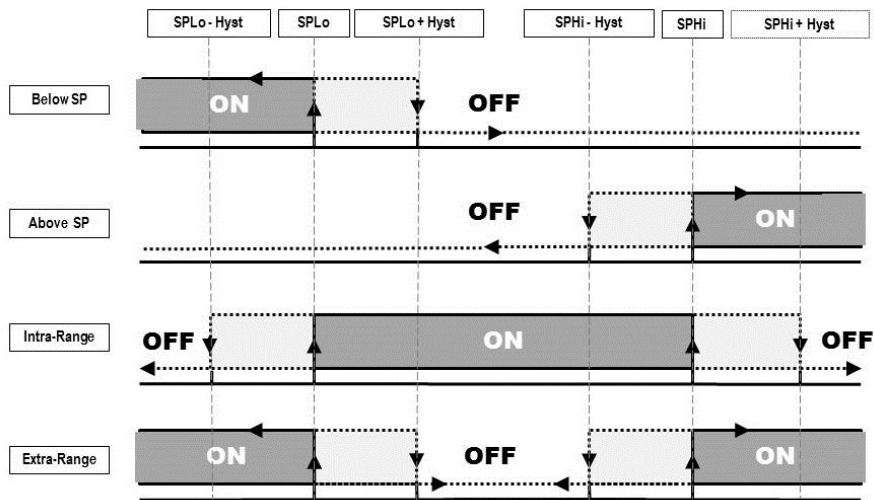

Fig. 07 – Conditions of activation and deactivation of the different alarm modes

5.3 ANALOG OUTPUT CONFIGURATION

The device has a configurable analog output. You can configure it using the **NXperience** software (check the [Output Parameters](#) section), and you can define: the electrical pattern, the error mode and the excursion range of the pressure to be transmitted.

The electrical pattern can be selected between 0-10 V and 4-20 mA modes and the error mode determines the behavior of the analog output in case of sensor failure, as shown in **Table 03**:

Mode	Error Mode	
	Low	High
0 – 10 V	0 V	10 V
4 – 20 mA	3.6 mA	21.0 mA

Table 03 – Behavior of the analog output in case of sensor failure

The excursion of the electric signal respects the values set in the configuration of the lower and upper transmission limits, which allows customizing the differential pressure range. The factory setting also defines the upper and lower limits of the sensor as the maximum operating limits of each respective model.

The device is factory set with the 4-20 mA electrical standard and the pressure unit in mbar. Any changes in the pressure unit configuration readjust the values of the transmission limits to the operating limits of the device.

6 USB INTERFACE

The USB interface is used for CONFIGURING or MONITORING the device.

For CONFIGURATION, you must use the **NXperience** software to create, view, save, and open configurations from the device or files on your computer. The feature to save and open configurations in files makes it possible to transfer configurations between devices and make backup copies.



NXperience allows you to update the **NP785 Ultra Low Differential Pressure Transmitter** firmware (internal software) via USB interface.

For MONITORING, any supervision (SCADA) or laboratory software that supports Modbus RTU communication over a serial communication port can be used. When connected to a computer USB port, **NP785 Ultra Low Differential Pressure Transmitter** is recognized as a conventional serial port (COM x). Use **NXperience** or refer to the Device Manager on Windows Control Panel to identify the COM port assigned to the device.

Refer to the Modbus memory mapping in the device communication manual and its supervision software documentation to perform MONITORING.

Follow the procedure below to use the device USB communication:

- Download **NXperience** from our website and install it on your computer (see chapter [NXperience Software](#)). The USB drivers required for communication will be installed along with the software.
- Connect the USB cable between the device and the computer. The device doesn't need a power supply. The USB will provide enough power for the communication operation (other device functions may not operate).
- Launch **NXperience**, configure the communication and start the device recognition.

	<p>The USB interface IS NOT ISOLATED from the retransmission output and alarm output. Its purpose is temporary use during CONFIGURATION and MONITORING periods. For the safety of people and device, it should only be used with the device fully disconnected from the external power supply input.</p>
	<p>In any other situation, the USB interface use is possible, but requires a careful analysis by the person responsible for its installation.</p> <p>For MONITORING for long periods and with inputs and outputs connected, it is recommended to use the RS485, available or optional in most of our device.</p>

7 SERIAL COMMUNICATION

The **NP785 Ultra Low Differential Pressure Transmitter** can be recognized on an RS485 network with Modbus RTU protocol as a slave device. All the configurable parameters of the device can be read and/or written via serial communication.

The device supports writing in Broadcast mode, using the slave address Modbus **0**.

The available Modbus commands are as follows:

03 – Read Holding Register

05 – Write Single Coil

06 – Write Single Register

16 – Write Multiple Register

7.1 REGISTERS TABLE

NP785-05 Model: Output Registers Table								
Address	Name	Description	R/W	Type	Standard	Min.	Max.	Decimal Places
0	HR_PRESS	Differential pressure value	RO	int_32	0	-5 mbar -72,52 mpsi -2,007 inH2O -50,98 mmH2O -500,0 Pa	5 mbar 72,52 mpsi 2,007 inH2O 50,98 mmH2O 500,0 Pa	mbar: 3 decimal places mpsi: 2 decimal places inH2O: 3 decimal places mmH2O: 2 decimal places Pa: 1 decimal place
1	HR_PRESS_H							
2	HR_PRESS_MIN	Minimum differential pressure value logged	RO	int_32	0	-5 mbar -72,52 mpsi -2,007 inH2O -50,98 mmH2O -500,0 Pa	5 mbar 72,52 mpsi 2,007 inH2O 50,98 mmH2O 500,0 Pa	mbar: 3 decimal places mpsi: 2 decimal places inH2O: 3 decimal places mmH2O: 2 decimal places Pa: 1 decimal place
3	HR_PRESS_MIN_H							
4	HR_PRESS_MAX	Maximum differential pressure value logged	RO	int_32	0	-5 mbar -72,52 mpsi -2,007 inH2O -50,98 mmH2O -500,0 Pa	5 mbar 72,52 mpsi 2,007 inH2O 50,98 mmH2O 500,0 Pa	mbar: 3 decimal places mpsi: 2 decimal places inH2O: 3 decimal places mmH2O: 2 decimal places Pa: 1 decimal place
5	HR_PRESS_MAX_H							

Table 04 – NP785-05 Model: Output Registers Table

NP785-05 Model: Configuration Registers Table								
Address	Name	Description	R/W	Type	Standard	Min.	Max.	Decimal Places
100	HR_SENSOR_TYPE	Sensor type: 5 mbar or 20 mbar	RO	uint16	0	0	1	N.A.
101	HR_OUT1_TYPE	Retransmission output type*	RW	uint16	0	0	1	N.A.
103	HR_OUT1_IN_HIGH_LIMIT	Retransmission upper limit input	RW	int_32	5 mbar 72,52 mpsi 2,007 inH2O 50,98 mmH2O 500,0 Pa	-5 mbar -72,52 mpsi -2,007 inH2O -50,98 mmH2O -500,0 Pa	5 mbar 72,52 mpsi 2,007 inH2O 50,98 mmH2O 500,0 Pa	mbar: 3 decimal places mpsi: 2 decimal places inH2O: 3 decimal places mmH2O: 2 decimal places Pa: 1 decimal place
104	HR_OUT1_IN_HIGH_LIMIT_H							
105	HR_OUT1_IN_LOW_LIMIT	Retransmission lower limit input	RW	int_32	-5 mbar -72,52 mpsi -2,007 inH2O -50,98 mmH2O -500,0 Pa	-5 mbar -72,52 mpsi -2,007 inH2O -50,98 mmH2O -500,0 Pa	5 mbar 72,52 mpsi 2,007 inH2O 50,98 mmH2O 500,0 Pa	mbar: 3 decimal places mpsi: 2 decimal places inH2O: 3 decimal places mmH2O: 2 decimal places Pa: 1 decimal place
106	HR_OUT1_IN_LOW_LIMIT_H							
107	HR_OUT1_ERR	Error type (higher or lower)*	RW	uint16	1	0	1	N.A.
108	HR_OUT1_HIGH_LIMIT	Retransmission upper limit	RO	int_32	5 mbar 72,52 mpsi 2,007 inH2O 50,98 mmH2O 500,0 Pa	-5 mbar -72,52 mpsi -2,007 inH2O -50,98 mmH2O -500,0 Pa	5 mbar 72,52 mpsi 2,007 inH2O 50,98 mmH2O 500,0 Pa	mbar: 3 decimal places mpsi: 2 decimal places inH2O: 3 decimal places mmH2O: 2 decimal
109	HR_OUT1_HIGH_LIMIT_H							

								places Pa: 1 decimal place
110	HR_OUT1_LOW_LIMIT							mbar: 3 decimal places
111	HR_OUT1_LOW_LIMIT_H	Retransmission lower limit	RO	int_32	-5 mbar -72,52 mpsi -2,007 inH2O -50,98 mmH2O -500,0 Pa	-5 mbar -72,52 mpsi -2,007 inH2O -50,98 mmH2O -500,0 Pa	5 mbar 72,52 mpsi 2,007 inH2O 50,98 mmH2O 500,0 Pa	mpsi: 2 decimal places inH2O: 3 decimal places mmH2O: 2 decimal places Pa: 1 decimal places
113	HR_PRESS_FLTR	Filter for differential pressure reading	RW	uint16	0	0	300	0
115	HR_UNIT_SYSTEM	Units configuration*	RW	uint16	0	0	4	N.A.
122	HR_A1FU	Alarm type*	RW	uint16	5	0	5	N.A.
123	HR_A1SPHI_IN	Alarm Setpoint High Input	RW	int_32	0	-5 mbar -72,52 mpsi -2,007 inH2O -50,98 mmH2O -500,0 Pa	5 mbar 72,52 mpsi 2,007 inH2O 50,98 mmH2O 500,0 Pa	mbar: 3 decimal places mpsi: 2 decimal places inH2O: 3 decimal places mmH2O: 2 decimal places Pa: 1 decimal place
124	HR_A1SPHI_IN_H							
125	HR_A1SPLO_IN	Alarm Setpoint Low Input	RW	int_32	0	-5 mbar -72,52 mpsi -2,007 inH2O -50,98 mmH2O -500,0 Pa	5 mbar 72,52 mpsi 2,007 inH2O 50,98 mmH2O 500,0 Pa	mbar: 3 decimal places mpsi: 2 decimal places inH2O: 3 decimal places mmH2O: 2 decimal places Pa: 1 decimal place
126	HR_A1SPLO_IN_H							
127	HR_A1BL	Alarm block	RW	uint16	0	0	1	N.A.
128	HR_A1HY	Alarm hysteresis	RW	uint16	0	0	1 mbar 14,50 mpsi 0,401 inH2O 10,20 mmH2O 100,0 Pa	mbar: 3 decimal places mpsi: 2 decimal places inH2O: 3 decimal places mmH2O: 2 decimal places Pa: 1 decimal place
129	HR_A1T1	Alarm time ON	RW	uint16	0	0	6500	0
130	HR_A1T2	Alarm time OFF	RW	uint16	0	0	6500	0
131	HR_A1IERR	Determines the alarm status in case of sensor error	RW	uint16	0	0	1	N.A.
132	HR_A1SPHI	Alarm Setpoint High	RO	int_32	0	-5 mbar -72,52 mpsi -2,007 inH2O -50,98 mmH2O -500,0 Pa	5 mbar 72,52 mpsi 2,007 inH2O 50,98 mmH2O 500,0 Pa	mbar: 3 decimal places mpsi: 2 decimal places inH2O: 3 decimal places mmH2O: 2 decimal places Pa: 1 decimal place
133	HR_A1SPHI_H							
134	HR_A1SPLO	Alarm Setpoint Low	RO	int_32	0	-5 mbar -72,52 mpsi -2,007 inH2O -50,98 mmH2O -500,0 Pa	5 mbar 72,52 mpsi 2,007 inH2O 50,98 mmH2O 500,0 Pa	mbar: 3 decimal places mpsi: 2 decimal places inH2O: 3 decimal places mmH2O: 2 decimal places Pa: 1 decimal place
135	HR_A1SPLO_H							
137	HR_BAUD	Baud Rate*	RW	uint16	4	0	7	N.A.
138	HR_PRTY	Parity*	RW	uint16	0	0	2	N.A.
139	HR_ADDR	Slave address	RW	uint16	1	1	247	N.A.

146	HR_OFST_PRESS	Differential pressure Offset	RW	uint16	0	-1 mbar -14,50 mpsi -0,401 inH2O -10,20 mmH2O -100,0 Pa	1 mbar 14,50 mpsi 0,401 inH2O 10,20 mmH2O 100,0 Pa	mbar: 3 decimal places mpsi: 2 decimal places inH2O: 3 decimal places mmH2O: 2 decimal places Pa: 1 decimal place
152	HR_OUT1_FORCE_ENAB	Enables forcing output 1	RW	uint16	0	0	1	N.A.
153	HR_OUT1_FORCE_VAL	Forced value for output 1	RW	uint16	0	0,00 V 3,60 mA	10,00 V 21 mA	2
154	HR_A1_FORCE_ENAB	Enables forcing alarm 1	RW	uint16	0	0	1	N.A.
155	HR_A1_STATE	Changes forced status on alarm	RW	uint16	0	0	1	N.A.
156	HR_FORCE_IN_PRESS	Enables differential pressure forcing	RW	uint16	0	0	1	N.A.
157	HR_FORCE_PRESS_IN	Forced differential pressure value input	RW	int_32	0	-5 mbar -72,52 mpsi -2,007 inH2O -50,98 mmH2O -500,0 Pa	5 mbar 72,52 mpsi 2,007 inH2O 50,98 mmH2O 500,0 Pa	mbar: 3 decimal places mpsi: 2 decimal places inH2O: 3 decimal places mmH2O: 2 decimal places Pa: 1 decimal place
158	HR_FORCE_PRESS_IN_H							
159	HR_FORCE_PRESS	Forced differential pressure value	RO	int_32	0	-5 mbar -72,52 mpsi -2,007 inH2O -50,98 mmH2O -500,0 Pa	5 mbar 72,52 mpsi 2,007 inH2O 50,98 mmH2O 500,0 Pa	mbar: 3 decimal places mpsi: 2 decimal places inH2O: 3 decimal places mmH2O: 2 decimal places Pa: 1 decimal place
160	HR_FORCE_PRESS							
161	HR_RESET_MIN_MAX	Reset all lows and highs	RW	uint16	0	0	1	N.A.
166	HR_PRODUCT_TAG01	Equipment tag	RW	2 char	0	0x0000	0xFFFF	N.A.
167	HR_PRODUCT_TAG02		RW	2 char	0	0x0000	0xFFFF	N.A.
168	HR_PRODUCT_TAG03		RW	2 char	0	0x0000	0xFFFF	N.A.
169	HR_PRODUCT_TAG04		RW	2 char	0	0x0000	0xFFFF	N.A.
170	HR_PRODUCT_TAG05		RW	2 char	0	0x0000	0xFFFF	N.A.
171	HR_PRODUCT_TAG06		RW	2 char	0	0x0000	0xFFFF	N.A.
172	HR_PRODUCT_TAG07		RW	2 char	0	0x0000	0xFFFF	N.A.
173	HR_PRODUCT_TAG08		RW	2 char	0	0x0000	0xFFFF	N.A.
174	HR_PRODUCT_TAG09		RW	2 char	0	0x0000	0xFFFF	N.A.
175	HR_PRODUCT_TAG10		RW	2 char	0	0x0000	0xFFFF	N.A.

* Check the **Table 10** for more information about the device configuration registers.

Table 05 – NP785-05 Model: Configuration Registers Table

The registers 103 to 106, 123 to 126, 157 and 158 must be used by the user to enter the values of their respective parameters. If they are within limits, the device will automatically pass these values to registers 108 to 111, 132 to 135, 159 and 160, which show the values considered during the operation. In case of extrapolation of limits, this condition will be signaled in register 343 (HR_DIAGNOSE03).

For 32-bit data, the two registers that compose them must be read and/or written in order for the values to be updated.

NP785-05 Model: Information Registers Table								
Address	Name	Description	R/W	Type	Standard	Min.	Max.	Decimal Places
300	HR_NUM_SERIEH	Serial Number High	RO	uint_32	-	0x0000	0xFFFF	N.A.
301	HR_NUM_SERIEL	Serial Number Low			-	0x0000	0xFFFF	N.A.
302	HR_VERSAO_SW	Firmware version	RO	uint16	-	0x0000	0xFFFF	2
303	HR_RELEASE	Release version	RO	uint16	-	0x0000	0xFFFF	0
304	HR_ID	ID	RO	uint16	0xB3	0x0000	0xFFFF	N.A.
305	HR_MODEL	Informs the product model	RO	uint16	0	0x0000	0xFFFF	N.A.
341	HR_DIAGNOSE01	Diagnostic**	RO	uint16	0	0x0000	0xFFFF	N.A.
342	HR_DIAGNOSE02		RO	uint16	0	0x0000	0xFFFF	N.A.
343	HR_DIAGNOSE03		RO	uint16	0	0x0000	0xFFFF	N.A.
359	HR_PRESS_HIGH_LIMIT	Maximum limits	RO	uint32	5 mbar 72,52 mpsi 2,007 inH2O 50,98 mmH2O 500,0 Pa	-5 mbar -72,52 mpsi -2,007 inH2O -50,98 mmH2O -500,0 Pa	5 mbar 72,52 mpsi 2,007 inH2O 50,98 mmH2O 500,0 Pa	mbar: 3 decimal places mpsi: 2 decimal places inH2O: 3 decimal places mmH2O: 2 decimal places Pa: 1 decimal place
360	HR_PRESS_HIGH_LIMIT_H							
361	HR_PRESS_LOW_LIMIT	Minimum limits	RO	uint32	-5 mbar -72,52 mpsi -2,007 inH2O -50,98 mmH2O -500,0 Pa	-5 mbar -72,52 mpsi -2,007 inH2O -50,98 mmH2O -500,0 Pa	5 mbar 72,52 mpsi 2,007 inH2O 50,98 mmH2O 500,0 Pa	mbar: 3 decimal places mpsi: 2 decimal places inH2O: 3 decimal places mmH2O: 2 decimal places Pa: 1 decimal place
362	HR_PRESS_LOW_LIMIT_H							

** Check the **Table 11** for more information about the device configuration registers.

Table 06 – NP785-05 Model: Information registers

NP785-20 Model: Output Registers Table								
Address	Name	Description	R/W	Type	Standard	Min.	Max.	Decimal Places
0	HR_PRESS	Differential pressure value	RO	int_32	0	-20 mbar -290,08 mpsi -8,029 inH2O -203,94 mmH2O -2000,0 Pa	20 mbar 290,08 mpsi 8,029 inH2O 203,94 mmH2O 2000,0 Pa	mbar: 3 decimal places mpsi: 2 decimal places inH2O: 3 decimal places mmH2O: 2 decimal places Pa: 1 decimal place
1	HR_PRESS_H							
2	HR_PRESS_MIN	Minimum differential pressure value logged	RO	int_32	0	-20 mbar -290,08 mpsi -8,029 inH2O -203,94 mmH2O -2000,0 Pa	20 mbar 290,08 mpsi 8,029 inH2O 203,94 mmH2O 2000,0 Pa	mbar: 3 decimal places mpsi: 2 decimal places inH2O: 3 decimal places mmH2O: 2 decimal places Pa: 1 decimal place
3	HR_PRESS_MIN_H							
4	HR_PRESS_MAX	Maximum differential pressure value logged	RO	int_32	0	-20 mbar -290,08 mpsi -8,029 inH2O -203,94 mmH2O -2000,0 Pa	20 mbar 290,08 mpsi 8,029 inH2O 203,94 mmH2O 2000,0 Pa	mbar: 3 decimal places mpsi: 2 decimal places inH2O: 3 decimal places mmH2O: 2 decimal places Pa: 1 decimal place
5	HR_PRESS_MAX_H							

Table 07 – NP785-20 Model:16:30 Output Registers Table

NP785 Model: Configuration Registers Table

Address	Name	Description	R/W	Type	Standard	Min.	Max.	Decimal Places
100	HR_SENSOR_TYPE	Sensor type: 5 mbar or 20 mbar	RO	uint16	1	0	1	N.A.
101	HR_OUT1_TYPE	Retransmission output type*	RW	uint16	0	0	1	N.A.
103	HR_OUT1_IN_HIGH_LIMIT	Retransmission upper limit input	RW	int_32	20 mbar 290,08 mpsi 8,029 inH2O 203,94 mmH2O 2000,0 Pa	-20 mbar -290,08 mpsi -8,029 inH2O -203,94 mmH2O -2000,0 Pa	20 mbar 290,08 mpsi 8,029 inH2O 203,94 mmH2O 2000,0 Pa	mbar: 3 decimal places mpsi: 2 decimal places inH2O: 3 decimal places mmH2O: 2 decimal places Pa: 1 decimal place
104	HR_OUT1_IN_HIGH_LIMIT_H							
105	HR_OUT1_IN_LOW_LIMIT	Retransmission lower limit input	RW	int_32	-20 mbar -290,08 mpsi -8,029 inH2O -203,94 mmH2O -2000,0 Pa	-20 mbar -290,08 mpsi -8,029 inH2O -203,94 mmH2O -2000,0 Pa	20 mbar 290,08 mpsi 8,029 inH2O 203,94 mmH2O 2000,0 Pa	mbar: 3 decimal places mpsi: 2 decimal places inH2O: 3 decimal places mmH2O: 2 decimal places Pa: 1 decimal place
106	HR_OUT1_IN_LOW_LIMIT_H							
107	HR_OUT1_ERR	Error type (higher or lower)*	RW	uint16	1	0	1	N.A.
108	HR_OUT1_HIGH_LIMIT	Retransmission upper limit	RO	int_32	20 mbar 290,08 mpsi 8,029 inH2O 203,94 mmH2O 2000,0 Pa	-20 mbar -290,08 mpsi -8,029 inH2O -203,94 mmH2O -2000,0 Pa	20 mbar 290,08 mpsi 8,029 inH2O 203,94 mmH2O 2000,0 Pa	mbar: 3 decimal places mpsi: 2 decimal places inH2O: 3 decimal places mmH2O: 2 decimal places Pa: 1 decimal place
109	HR_OUT1_HIGH_LIMIT_H							
110	HR_OUT1_LOW_LIMIT	Retransmission lower limit	RO	int_32	-20 mbar -290,08 mpsi -8,029 inH2O -203,94 mmH2O -2000,0 Pa	-20 mbar -290,08 mpsi -8,029 inH2O -203,94 mmH2O -2000,0 Pa	20 mbar 290,08 mpsi 8,029 inH2O 203,94 mmH2O 2000,0 Pa	mbar: 3 decimal places mpsi: 2 decimal places inH2O: 3 decimal places mmH2O: 2 decimal places Pa: 1 decimal place
111	HR_OUT1_LOW_LIMIT_H							
113	HR_PRESS_FLTR	Filter for differential pressure reading	RW	uint16	0	0	300	0
115	HR_UNIT_SYSTEM	Units configuration*	RW	uint16	0	0	4	N.A.
122	HR_A1FU	Alarm type*	RW	uint16	5	0	5	N.A.
123	HR_A1SPHI_IN	Alarm Setpoint High Input	RW	int_32	0	-20 mbar -290,08 mpsi -8,029 inH2O -203,94 mmH2O -2000,0 Pa	20 mbar 290,08 mpsi 8,029 inH2O 203,94 mmH2O 2000,0 Pa	mbar: 3 decimal places mpsi: 2 decimal places inH2O: 3 decimal places mmH2O: 2 decimal places Pa: 1 decimal place
124	HR_A1SPHI_IN_H							
125	HR_A1SPLO_IN	Alarm Setpoint Low Input	RW	int_32	0	-20 mbar -290,08 mpsi -8,029 inH2O -203,94 mmH2O -2000,0 Pa	20 mbar 290,08 mpsi 8,029 inH2O 203,94 mmH2O 2000,0 Pa	mbar: 3 decimal places mpsi: 2 decimal places inH2O: 3 decimal places mmH2O: 2 decimal places Pa: 1 decimal place
126	HR_A1SPLO_IN_H							
127	HR_A1BL	Alarm block	RW	uint16	0	0	1	N.A.
128	HR_A1HY	Alarm hysteresis	RW	uint16	0	0	4 mbar 58,02 mpsi 1,606 inH2O 40,78 mmH2O 400,0 Pa	mbar: 3 decimal places mpsi: 2 decimal places inH2O: 3 decimal places mmH2O: 2 decimal places Pa: 1 decimal place
129	HR_A1T1	Alarm time ON	RW	uint16	0	0	6500	0
130	HR_A1T2	Alarm time OFF	RW	uint16	0	0	6500	0
131	HR_A1IERR	Determines the alarm status in case of sensor error	RW	uint16	0	0	1	N.A.
132	HR_A1SPHI	Alarm Setpoint High	RO	int_32	0	-20 mbar	20 mbar	mbar: 3 decimal places

133	HR_A1SPHI_H					-290,08 mpsi -8,029 inH2O -203,94 mmH2O -2000,0 Pa	290,08 mpsi 8,029 inH2O 203,94 mmH2O 2000,0 Pa	mpsi: 2 decimal places inH2O: 3 decimal places mmH2O: 2 decimal places Pa: 1 decimal place
134	HR_A1SPLO	Alarm Setpoint Low	RO	uint_32	0			
135	HR_A1SPLO_H							
137	HR_BAUD	Baud Rate*	RW	uint16	4	0	7	N.A.
138	HR_PRTY	Parity*	RW	uint16	0	0	2	N.A.
139	HR_ADDR	Slave address	RW	uint16	1	1	247	N.A.
146	HR_OFST_PRESS	Differential pressure offset	RW	uint16	0	-4 mbar -58,02 mpsi -1,606 inH2O -40,78 mmH2O -400,0 Pa	4 mbar 58,02 mpsi 1,606 inH2O 40,78 mmH2O 400,0 Pa	mbar: 3 decimal places mpsi: 2 decimal places inH2O: 3 decimal places mmH2O: 2 decimal places Pa: 1 decimal place
152	HR_OUT1_FORCE_ENAB	Enables forcing output 1	RW	uint16	0	0	1	N.A.
153	HR_OUT1_FORCE_VAL	Forced value for output 1	RW	uint16	0	0,00 V 3,60 mA	10,00 V 21 mA	2
154	HR_A1_FORCE_ENAB	Enables forcing alarm 1	RW	uint16	0	0	1	N.A.
155	HR_A1_STATE	Changes forced status on alarm	RW	uint16	0	0	1	N.A.
156	HR_FORCE_IN_PRESS	Enables differential pressure forcing	RW	uint16	0	0	1	N.A.
157	HR_FORCE_PRESS_IN	Forced differential pressure value input	RW	uint_32	0			
158	HR_FORCE_PRESS_IN_H							
159	HR_FORCE_PRESS	Forced differential pressure value	RO	uint_32	0			
160	HR_FORCE_PRESS_H							
161	HR_RESET_MIN_MAX	Reset all lows and highs	RW	uint16	0	0	1	N.A.
166	HR_PRODUCT_TAG01	Equipment tag	RW	2 char	0	0x0000	0xFFFF	N.A.
167	HR_PRODUCT_TAG02		RW	2 char	0	0x0000	0xFFFF	N.A.
168	HR_PRODUCT_TAG03		RW	2 char	0	0x0000	0xFFFF	N.A.
169	HR_PRODUCT_TAG04		RW	2 char	0	0x0000	0xFFFF	N.A.
170	HR_PRODUCT_TAG05		RW	2 char	0	0x0000	0xFFFF	N.A.
171	HR_PRODUCT_TAG06		RW	2 char	0	0x0000	0xFFFF	N.A.
172	HR_PRODUCT_TAG07		RW	2 char	0	0x0000	0xFFFF	N.A.
173	HR_PRODUCT_TAG08		RW	2 char	0	0x0000	0xFFFF	N.A.
174	HR_PRODUCT_TAG09		RW	2 char	0	0x0000	0xFFFF	N.A.
175	HR_PRODUCT_TAG10		RW	2 char	0	0x0000	0xFFFF	N.A.

* Check the **Table 10** for more information about the device configuration registers.

Table 08 - NP785 Model: Configuration Registers Table

The registers 103 to 106, 123 to 126, 157 and 158 must be used by the user to enter the values of their respective parameters. If they are within limits, the device will automatically pass these values to registers 108 to 111, 132 to 135, 159 and 160, which show the values considered during the operation. In case of extrapolation of limits, this condition will be signaled in register 343 (HR_DIAGNOSE03).

For 32-bit data, the two registers that compose them must be read and/or written in order for the values to be updated.

NP785-20 Model: Information Registers Table								
Address	Name	Description	R/W	Type	Standard	Min.	Max.	Decimal Places
300	HR_NUM_SERIEH	Serial number High	RO	uint_32	-	0x0000	0xFFFF	N.A.
301	HR_NUM_SERIEL	Serial number Low			-	0x0000	0xFFFF	N.A.
302	HR_VERSAO_SW	Firmware version	RO	uint16	-	0x0000	0xFFFF	2
303	HR_RELEASE	Release version	RO	uint16	-	0x0000	0xFFFF	0
304	HR_ID	ID	RO	uint16	0xB3	0x0000	0xFFFF	N.A.
305	HR_MODEL	Informs the product model	RO	uint16	0	0x0000	0xFFFF	N.A.
341	HR_DIAGNOSE01	Diagnostic**	RO	uint16	0	0x0000	0xFFFF	N.A.
342	HR_DIAGNOSE02		RO	uint16	0	0x0000	0xFFFF	N.A.
343	HR_DIAGNOSE03		RO	uint16	0	0x0000	0xFFFF	N.A.
359	HR_PRESS_HIGH_LIMIT	Maximum limits	RO	uint32	20 mbar 290,08 mpsi 8,029 inH2O 203,94 mmH2O 2000,0 Pa	-20 mbar -290,08 mpsi -8,029 inH2O -203,94 mmH2O -2000,0 Pa	20 mbar 290,08 mpsi 8,029 inH2O 203,94 mmH2O 2000,0 Pa	mbar: 3 decimal places mpsi: 2 decimal places inH2O: 3 decimal places mmH2O: 2 decimal places Pa: 1 decimal place
360	HR_PRESS_HIGH_LIMIT_H							
361	HR_PRESS_LOW_LIMIT	Minimum limits	RO	uint32	-20 mbar -290,08 mpsi -8,029 inH2O -203,94 mmH2O -2000,0 Pa	-20 mbar -290,08 mpsi -8,029 inH2O -203,94 mmH2O -2000,0 Pa	20 mbar 290,08 mpsi 8,029 inH2O 203,94 mmH2O 2000,0 Pa	mbar: 3 decimal places mpsi: 2 decimal places inH2O: 3 decimal places mmH2O: 2 decimal places Pa: 1 decimal place
362	HR_PRESS_LOW_LIMIT_H							

** Check the **Table 11** for more information about the device configuration registers.

Table 09 – NP785-20 Model: Information Registers

Table 10 lists the device configuration registers and the captions for their respective values:

Register	Name	Value	Description
101	HR_OUT1_TYPE	0	Output 4-20 mA; Output 0-10 V.
		1	
107	HR_OUT1_ERR	0	Low alarm in case of failure; High alarm in case of failure.
		1	
115	HR_UNIT_SYSTEM	0	Unity: mbar; Unity: mpsi; Unity: inH2O; Unity: mmH2O; Unity: Pa.
		1	
		2	
		3	
		4	
122	HR_A1FU	0	Alarm: Off; Alarm: Sensor Error; Alarm: Lower Setpoint; Alarm: Higher Setpoint; Alarm: Intra-range; Alarm: Extra-range.
		1	
		2	
		3	
		4	
		5	
137	HR_BAUD	0	<i>Baud Rate:</i> 1200 bps; <i>Baud Rate:</i> 2400 bps; <i>Baud Rate:</i> 4800 bps; <i>Baud Rate:</i> 9600 bps; <i>Baud Rate:</i> 19200 bps; <i>Baud Rate:</i> 38400 bps; <i>Baud Rate:</i> 57600 bps; <i>Baud Rate:</i> 115200 bps.
		1	
		2	
		3	
		4	
		5	
		6	
		7	
138	HR_PRTY	0	Parity: No parity; Parity: Odd parity; Parity: Even parity.
		1	
		2	

Table 10 – Subtitle

Table 11 shows the diagnostic bits:

Register	Name	Description	Bit
HR_DIAGNOSE01	DIAG_RESTART_UNITS_ERROR	Units Configuration error.	0
	DIAG_OUT1_OVERLOAD	Alarm output overload detection.	1
	DIAG_ALM1_OUT_STATUS	Forced alarm state.	3
	DIAG_ALM1_STATUS	Alarm status.	5
	DIAG_FORCE_ALM1	Forced alarm function is enabled.	10
	DIAG_FORCE_OUT1	Forced output function is enabled.	12
HR_DIAGNOSE02	DIAG_SENSOR_ERROR	Differential pressure sensor error.	0
HR_DIAGNOSE03	DIAG_OUT1_LIMIT_OOR	Input of retransmission limits outside the range.	1
	DIAG_ALM1_SETPT_OOR	Input of alarm setpoints outside the range.	3
	DIAG_FORCE_PRESS_OOR	Input of pressure forcing values out of range.	6

Table 11 – Diagnostic Bits

8 NXPERIENCE SOFTWARE

NXperience software is the leading configuration, data download and analysis tool for the **NP785 Ultra Low Differential Pressure Transmitter**. It allows you to explore all the device's features by communicating via the USB interface.

This manual describes the software's generic features. For instructions about device configuration, check the specific operating manual. The software and its manual can be downloaded from our website www.novusautomation.com, in the Downloads Area.

8.1 INSTALLING NXPERIENCE

To install **NXperience**, just execute the **NXperienceSetup.exe** file, available from our website.

8.2 RUNNING NXPERIENCE

When opening **NXperience** software, the home screen is displayed:

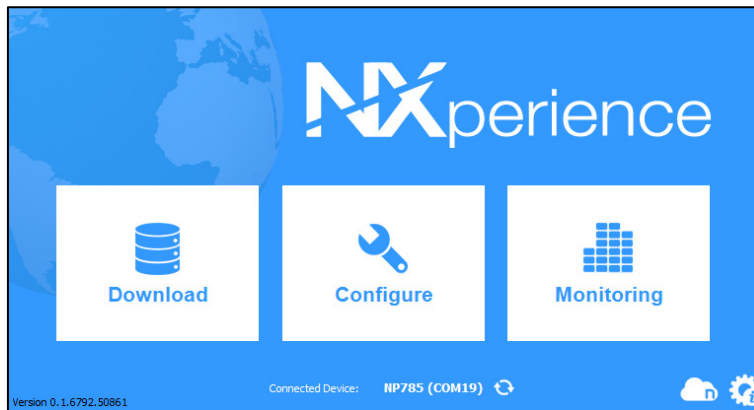

Fig. 08 – NXperience home screen

To communicate with the software, the **NP785 Ultra Low Differential Pressure Transmitter** must be connected to the computer and with the previously installed USB drivers.

Then you can click on **Configure** or **Monitor**. The **Download** option is not available for this device model.

The first time you read a device, you must select the device to be connected. Simply double click on the desired device or, once it is selected, click on the **Ok** button. This device will be adopted as the default option for the next times the software performs the communication process.



Fig. 09 – Select Device screen

8.3 CONFIGURING WITH NXPERIENCE

To configure the device, it must be connected to a USB port on the computer.

When clicking on the **Configure** button, the following screen is displayed:

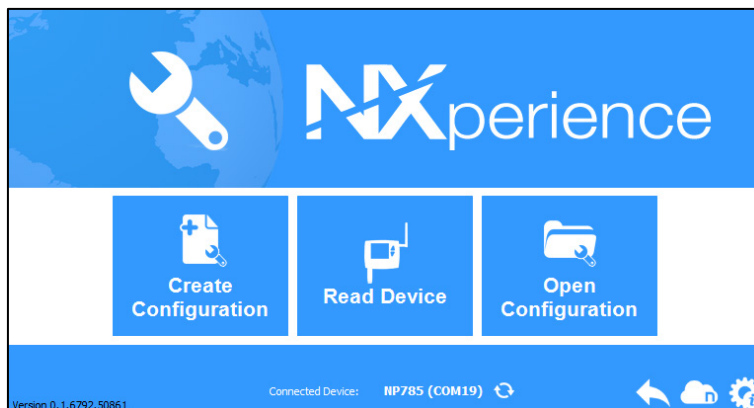

Fig. 10 – Configuring the device screen

The **Create Configuration** button creates a configuration from scratch, without needing the device. This configuration can be saved in a file for future use or can be recorded to a connected device.

The **Open Configuration** button reads a configuration file already created.

The **Read Device** button reads the current device configuration. When selecting this option, all features available for configuration will be displayed, as shown in the **Fig. 11**:

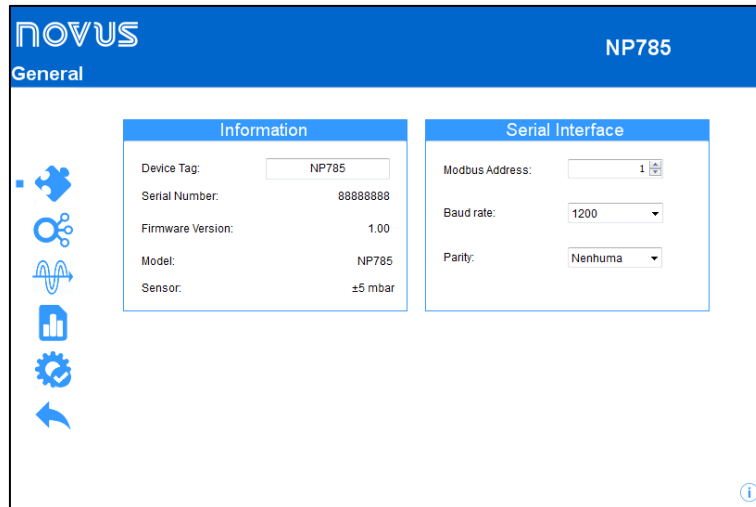

Fig. 11 – Configuration screen



General: On this tab, the user can assign an identification name to the device and define the configuration parameters for the serial interface. Additionally, the device model, serial number, firmware version and the maximum and minimum pressure range of the sensor can be identified.



Input: On this tab, the user can select the system of measures to be used by the device, in addition to configuring the offset and digital filter for the pressure sensor input.



Output: On this tab, the user can configure the transmission analog output and the alarm output.



Diagnostics: On this tab, the user can check if the device is functioning properly by forcing the pressure readings and forcing the alarm output.



Finalization: On this tab, the user can send the configuration to the device, save the configurations in a file, update the device firmware and configure a password to protect the device.



Back: Returns to **NXperience** home screen.

8.3.1 GENERAL PARAMETERS

By clicking on the  icon, you can view information of the device being configured and the serial interface configuration parameters.

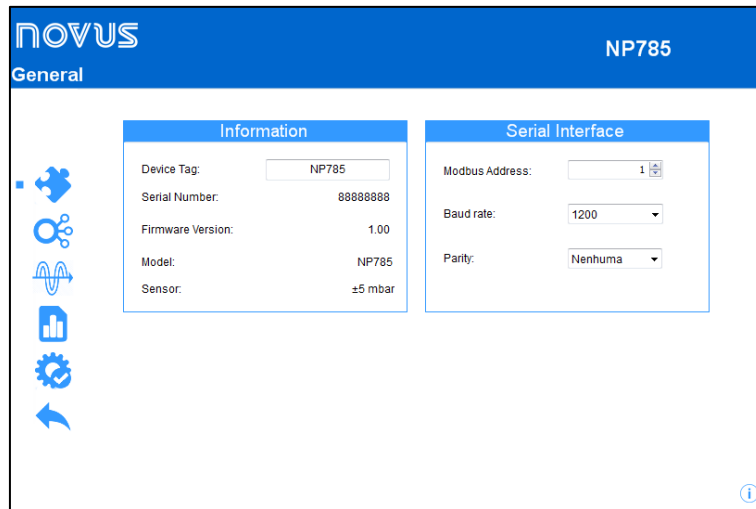



Fig. 12 – General screen

In the **Device Tag** parameter, you can name the device to be configured to make it easily identifiable within a multi-device network. **Serial Number**, **Firmware Version**, and **Model** are non-editable parameters that are read by the software and directly from the device.

In order for the **NP785 Ultra Low Differential Pressure Transmitter** to be recognized as a slave device in a Modbus network, you must assign a unique **Modbus Address** in the network and configure the **Baud Rate** and **Parity**.

8.3.2 INPUT PARAMETERS

By clicking on the  icon, you can configure the pressure sensor input.

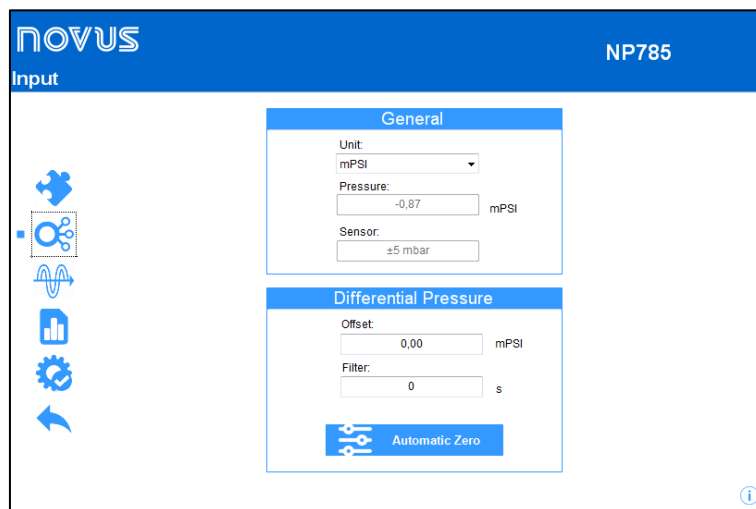
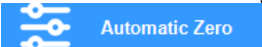

Fig. 13 – Input configuration screen

In the **Unit** parameter, you can select the units mbar, Mpsi, in H2O, mm H2O or pascal. By default, the unit of device is set to mbar.

The **Pressure** parameter informs the differential pressure of the device when the window opens.

The device also provides **Offset** and **Filter** adjustments, allowing not only small corrections to the sensor readings, but also to reduce the speed of response of the sensor.

The **Automatic Zero** configuration allows automatic offset adjustments. Make sure the pressure points are depressurized and click  to make the adjustment.

8.3.3 OUTPUT PARAMETERS

By clicking on the  icon, you can configure the transmission analog output and the alarm output.

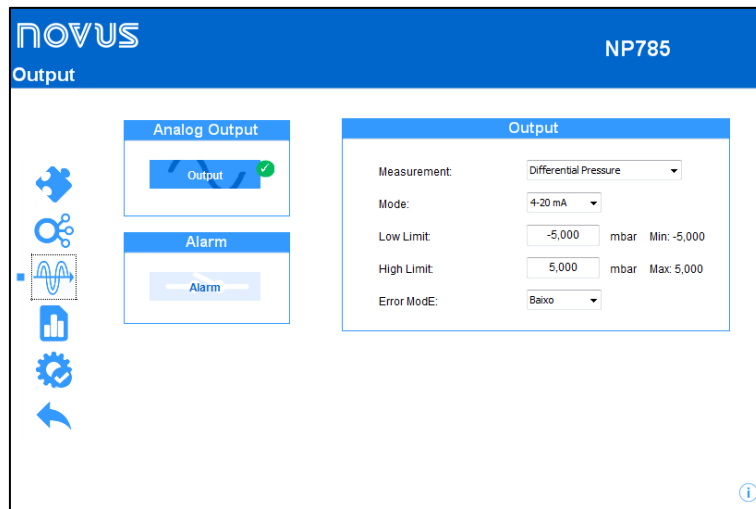

Fig. 14 – Output configuration screen

8.3.3.1 TRANSMISSION OUTPUT CONFIGURATION

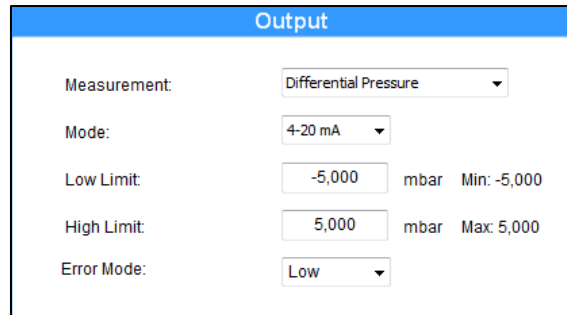

Fig. 15 – Output

The **Measurement** parameter allows the differential pressure quantity reading.

The analog output **Mode** allows you to select the electrical standard to be used for the transmission: 0-10 V or 4-20 mA. The electrical signal of the output will be proportional to the selected magnitude, respecting the values configured in the **Lower Limit** and in the **Upper Limit** parameters.

In case of sensor failure, the quantity to be transmitted by the analog output will go into **Error Mode**. For the error condition, you must select the **High** or **Low** state (check **Table 03**).

8.3.3.2 ALARM OUTPUT CONFIGURATION

To select the alarm output to be configured, you must click on the button  and enable it by sliding the enable switch to the right.

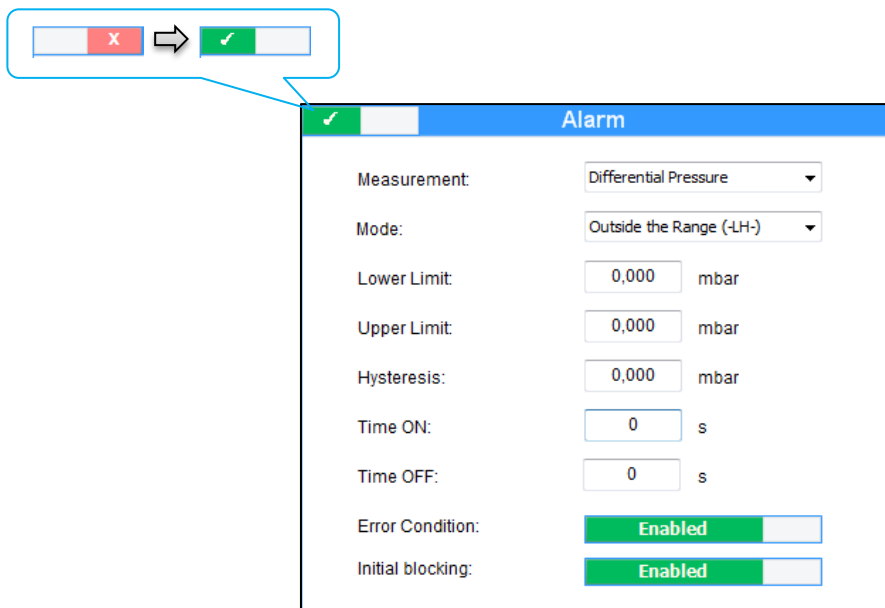

Fig. 16 – Alarm

The alarm output may be timed by the **Time On** and **Time Off** parameters.

If the equipment is configured in the **Value Lower than SPLo**, **Value Higher than SPHi**, **Inside the Range** or **Outside the Range** modes, the **Error Condition** parameter allows you to configure a safe state of the alarm output in case of sensor failure. Thus, the output will be on or off depending on the value set in this parameter.

Upper Limit and **Lower Limit** are the differential pressure values that act as alarm activation conditions that, together with the **Hysteresis**, define the barrier to be exceeded so that the channel exits the alarm situation. For more information about the alarm configuration, check the [Alarm Configuration](#) section.

8.3.4 DIAGNOSTICS

To access this section, the device must be connected to the USB port and the **Read Configuration** option must be selected.

By clicking on the  icon, you can check if the device is functioning properly by forcing the pressure readings. You can force a value either on the sensor reading or directly on the output.

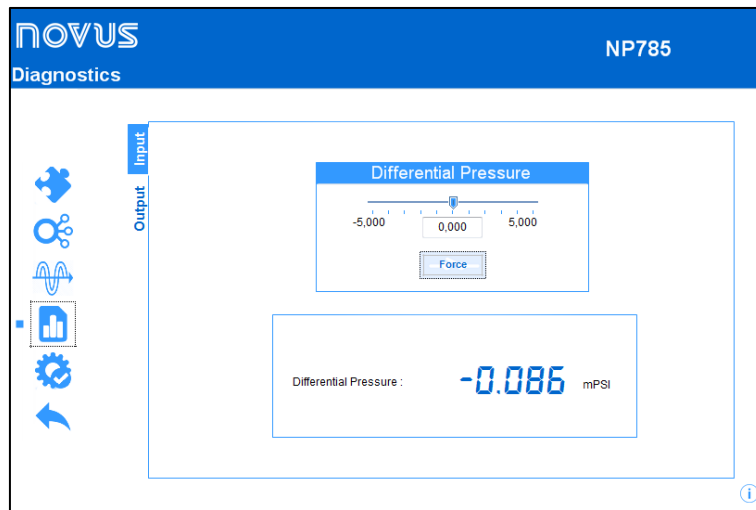

Fig. 17 – Diagnostics parameters

In the input diagnostics, you can view the differential pressure instantaneous value and force a value to it. To force a value, you must type the desired value in the field or run the slider to the desired value within the model pressure range and press the **Force** button.

In the output diagnostics, you can force the output in order to verify the correct operation of the device and test the settings applied to the **NP785 Differential Pressure Transmitter**.

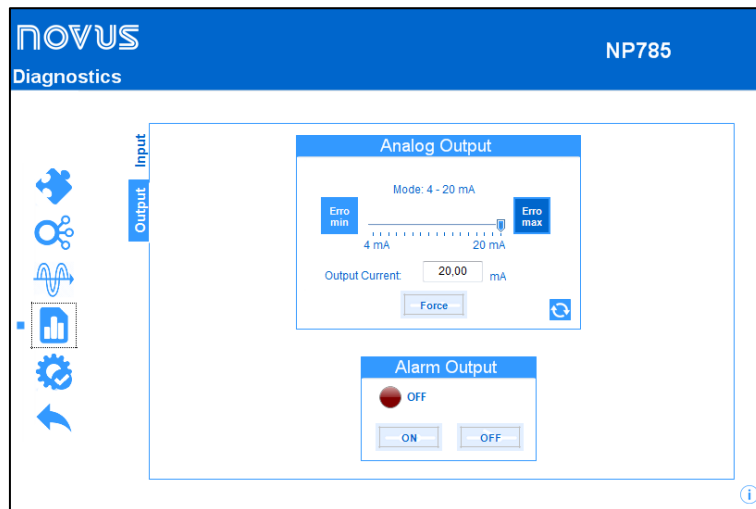

Fig. 18 – Output Diagnostics

To force a value at a transmission analog output, use the slider or type the desired value directly into the edit field and then press the **Force** button.

From this moment, the **NP785 Ultra Low Differential Pressure Transmitter** will force the adjusted value into the transmission output and the button used to perform the forcing will change to **Release**. If pressed again, the forced value will no longer be applied to the output.

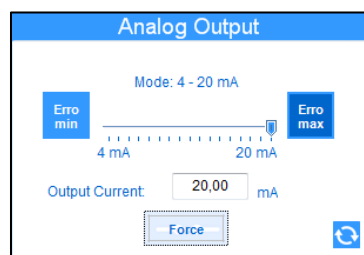

Fig. 19 – Output

For each analogue output, it is also possible to force the transmission of an error value by clicking the **Error min** and **Error max** buttons. These values depend on the mode (0-10 V or 4-20 mA) configured for each output.

The alarm output allows forcing the condition on and off. In some cases, it is possible that an alarm output is activated due to an alarm condition. Thus, it may be desirable to force the off state so that it is possible to identify any faults in the electrical installation or in the device configuration. The images below shows the forcing interface of the alarm output in the three possible conditions: No forcing, forcing on ON and forcing in OFF state.



Fig. 20 – Alarm output without forcing



Fig. 21 – Alarm output with forcing in on state

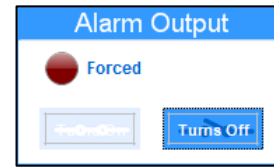



Fig. 22 – Alarm output with forcing in off state

8.3.5 FINALIZATION

By clicking on the  icon, you can send the configuration to the device, save the configurations in a file, update the device firmware and configure a password to protect it.

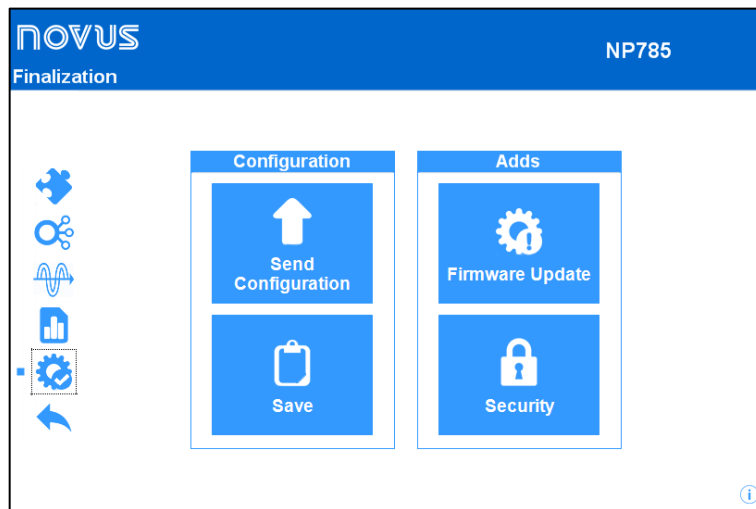

Fig. 23 – Finalization parameters

9 TECHNICAL SPECIFICATION

	NP785-05 MODEL	NP785-20 MODEL
Measuring Range	-5 to 5 mbar	-20 to 20 mbar
Burst Pressure	200 mbar	400 mbar
Proof Pressure*	100 mbar	300 mbar
Accuracy	1 % of maximum range F.S.**	1 % of maximum range F.S.**
Sensor Resolution (per unit)	7.630E-4 mbar	3.052E-3 mbar
	1.107E-2 mpsi	4.426E-2 mpsi
	3.063E-4 inH2O	1.226E-3 inH2O
	7.780E-3 mmH2O	3.112E-2 mmH2O
	7.630E-2 Pa	3.052E-1 Pa
Granularity of Pressure Recorders (per unit)	0.001 mbar	0.001 mbar
	0.01 mpsi	0.01 mpsi
	0.001 inH2O	0.001 inH2O
	0.01 mmH2O	0.01 mmH2O
	0.1 Pa	0.1 Pa
Start-Up Time	< 2 s	
Operating Temperature	-5 to 65 °C	-20 to 85 °C
Storage Temperature	-20 to 85 °C	
Power Supply Voltage	<ul style="list-style-type: none"> • Power supply from PWR terminals: 12 Vdc to 30 Vdc; • USB cable power: 4.75 Vdc to 5.25 Vdc. Internal protection against reverse polarity of the supply voltage.	
Power Supply Current	< 45 mA ± 10 % @ 24 Vdc	
Input	Two sockets for the pneumatic hose connection of 4 or 6 mm internal diameter.	
Output	They may be configured independently to operate with signals 0-10 V or 4-20 mA. <ul style="list-style-type: none"> • 0-10 V <ul style="list-style-type: none"> ○ Maximum current: 2 mA; ○ Resolution: 0.003 V. • 4-20 mA <ul style="list-style-type: none"> ○ Maximum load: 500 R; ○ Resolution: 0.006 mA. 	
Protection Rating	IP 20	
Housing	ABS + PC	
Electromagnetic Compatibility	EN/IEC 61326-1	
NXperience	10, 8 / 8.1 (32 and 64 bits), 7, Vista and XP. configurator software. Menus in Portuguese, Spanish, French and English.	
Certifications	CE	

* **Proof Pressure** is defined as the maximum pressure at which the device can be subjected and which still maintains its performance within specifications after returning to the operating range.

** **F.S.** : Full scale at 25 °C.

Table 12 – Technical Specifications

10 WARRANTY

Warranty conditions are available on our website www.novusautomation.com/warranty.